



User Guides

July 2018

This document contains Surface Hub user guides for Windows 10, version 1703 (Creators Update) and version 1607 (Anniversary Update).



User Guides.....i

User Guide for Surface Hub with Windows 10, version 1703.....1

About this guide..... 2

Replacement PC connections icons2

Wired Connect connections icons2

Additional connections icons.....2

Warning icons3

Meet Surface Hub 4

Surface Hub features..... 5

Wake / sleep..... 6

Interacting with Surface Hub 6

Touchscreen7

Keypad7

 Keypad indicator lights 7

 Pen indicator lights..... 8

Keyboard8

 Keys on top row..... 8

 Keys on left side 9

 Keys above touchpad 9

Welcome screen 11

Icons you'll see during a meeting.....12

Start screen..... 14

Open an app.....14

Switch or close apps.....15

My meetings and files 15

Tips app 16

Whiteboard 17

Whiteboard menu.....18

Smart Ink.....21

Whiteboard to Whiteboard collaboration22

Connect	23
<i>Wireless Connect.....</i>	23
<i>Wired Connect.....</i>	24
Conduct a meeting	24
Start an ad-hoc meeting.....	24
Start a scheduled meeting.....	24
<i>Invite people to your meeting</i>	25
Schedule a meeting.....	25
Add participants during a meeting.....	25
<i>Before the meeting</i>	25
<i>During the meeting</i>	25
<i>Accessing content attached to meeting invite.....</i>	26
Share content with remote participants	29
Upload content to the meeting space.....	29
Adjust cameras, mic, and volume	30
<i>Use apps in split-screen mode.....</i>	31
<i>Annotate</i>	31
<i>Save your data</i>	31
<i>End the meeting.....</i>	32
What if I forget to end my meeting?	33
<i>Restart a meeting</i>	33
Sign in to see your meetings and files	35
<i>Easy Authentication method.....</i>	36
<i>User name and password method</i>	40
Accessibility	43
<i>Using the magnifier.....</i>	43
Protect your data	43
Care and cleaning.....	44
<i>Keyboard and pen care</i>	44
<i>Replacements.....</i>	44
More information	44

User Guide for Surface Hub with Windows 10, version 1607.....45

About this guide..... 46

- Replacement PC connections icons.....46*
- Wired Connect connections icons.....46*
- Additional connections icons.....46*
- Warning icons.....47*

Meet Surface Hub 49

Surface Hub features..... 50

Wake / sleep..... 51

Interacting with Surface Hub 51

- Touchscreen52*
- Keypad52*
 - Keypad indicator lights.....52*
 - Pen indicator lights.....53*
- Keyboard.....53*
 - Keys on top row.....53*
 - Keys on left side54*
 - Keys above touchpad54*

Welcome screen 56

- Icons you'll see during a meeting.....56*

Start screen..... 58

- Open an app.....58*
- Switch or close apps.....59*

Get Started app..... 59

Whiteboard 60

- Whiteboard menu.....60*
- Smart Ink.....64*
- Whiteboard to Whiteboard collaboration65*

Connect 66

- Wireless Connect.....66*

<i>Wired Connect</i>	67
Conduct a meeting	67
Start an ad-hoc meeting	67
Start a scheduled meeting.....	67
<i>Invite people to your meeting</i>	68
Schedule a meeting	68
Add participants during a meeting	68
<i>Before the meeting</i>	68
<i>During the meeting</i>	68
<i>Accessing content attached to meeting invite</i>	69
Share content with remote participants	72
Upload content to the meeting space.....	72
Adjust cameras, mic, and volume	73
<i>Use apps in split-screen mode</i>	74
<i>Annotate</i>	74
<i>Save your data</i>	74
<i>End the meeting</i>	75
What if I forget to end my meeting?	76
<i>Restart a meeting</i>	76
Accessibility	78
<i>Using the magnifier</i>	78
Protect your data	78
Care and cleaning	79
<i>Keyboard and pen care</i>	79
<i>Replacements</i>	79
More information	79
Changes	80

This document does not provide you with any legal rights to any intellectual property in any Microsoft product. You may copy and use this document for your internal reference purposes.

Please refer to Microsoft Trademarks for a list of trademarked products.

All other trademarks are property of their respective owners.

User Guide for Surface Hub with Windows 10, version 1703







About this guide





Use the Surface Hub User Guide to master the features of Surface Hub, whether in an ad-hoc or scheduled meeting. This guide is also available online at <http://www.microsoft.com/surface/support/surface-hub> along with more Surface Hub information.

To start, familiarize yourself with these icons:

Replacement PC connections icons





Connector, location	Icon	Description
Switch, bottom I/O		Switches between using internal PC or external PC
DisplayPort, bottom I/O		Provides input for replacement PC (normally covered)
DisplayPort, bottom I/O		Provides second input for replacement PC (normally covered)
USB type B, bottom I/O		Provides USB connection for replacement PC to internal peripherals (normally covered)
USB type B, bottom I/O		Provides USB connection for integrated hub (normally covered)

Wired Connect connections icons





Connector, location	Icon	Description
DisplayPort, bottom I/O		Provides input for Wired Connect PC
HDMI, bottom I/O		Provides HDMI input for Wired Connect PC
VGA, bottom I/O		Provides VGA input for Wired Connect PC
3.5mm, bottom I/O		Provides analog audio input
USB type B, bottom I/O		Provides USB connection for video ingest touchback

Additional connections icons

Connector, location	Icon	Description
USB type A, side I/O	None	Provides one USB 3.0 connection for USB devices. Wake-on USB capable.

USB type A, bottom I/O with blue insulator		Provides USB 3.0 connection
3.5mm, bottom I/O		Provides analog audio out
DisplayPort, bottom I/O		Provides mirrored video out function to another display
IEC/EN60320-C13 receptacle with hard switch, bottom I/O	None	Provides AC input and compliance with EU power requirements
RJ45, bottom I/O		Connects to Ethernet
RJ11, bottom I/O		Connects to room control systems

Warning icons

Connector, location	Icon	Description
Attention: Caution		Identifies important safety and health messages
Warning: Hazardous voltage		Dangerous: Do not touch.
Read instructions		Read instruction manual for safety and health information.
Do not open		No user-serviceable parts inside.

Meet Surface Hub

Surface Hub is designed to support meetings, whether participants are around the world or in one room. Both ad-hoc meetings and scheduled Outlook meetings are supported, with Skype for Business as the driving force.

Surface Hub software features include:

- **Skype for Business:** Include Surface Hub in your Skype for Business meeting request. You can present the Surface Hub screen to remote participants, who can view it in their own Skype for Business window. If a remote user has something to present, it appears on the Surface Hub screen. See [Conduct a meeting](#), below.
- **Whiteboard:** Draw and write on a whiteboard similar to a OneNote page. Copy text and drawings from documents or webpages to the whiteboard, then annotate them. When you're done, mail the page to yourself and anyone else who needs it. See [Whiteboard](#), below.
- **Apps:** Built-in apps include web versions of Microsoft Edge, Word, Excel, PowerPoint, and OneNote. See [Open an app](#), below.
- **Connect:** Project audio and video to your Surface Hub from your computer, tablet, or phone using either cables provided by your Surface Hub administrator or Miracast. See [Connect](#), below.

Surface Hub features

Surface Hub comes in two sizes: 55" and 84", with the following features.



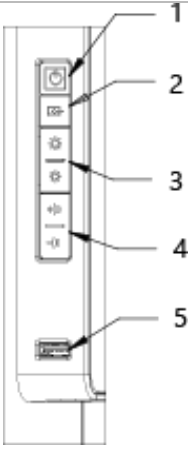

Touchscreen (9)	Use the touchscreen to open apps, write or draw on the whiteboard, join a meeting, invite participants, and more. See Interacting with Surface Hub , below.
Speakers (6) and microphone (1)	Stereo speakers and a microphone let you converse naturally with remote participants.
Cameras (2)	Surface Hub automatically switches between the two cameras so remote users can see the person speaking.
Motion sensors (3) and light sensor (4)	When Surface Hub detects that someone has entered the room, it wakes up and displays the Welcome screen. If it stops detecting movement, it goes to sleep.
Pen charging docks (5)	The Surface Hub pens click into place on the charging docks. Remove a pen to open the whiteboard. Put the pen back in the dock when you're done.
Pens	Use the tip of the pen to write, draw, capture, or select. Use the flat end as an eraser.

Keyboard	Sit back and use the keyboard to operate your Surface Hub. Specialized keys give you quick access to Surface Hub features. See Surface Hub keyboard , below.				
NFC reader	This lets you send files from a near-field communications device, such as a smartphone, to the Surface Hub screen.				
Integrated computer (10)	Surface Hub has an onboard computer that supports Microsoft Edge and Office 365 apps like Word and PowerPoint.				
Keypad (7) and USB 3.0 port (8)					
	<table border="1"> <tr> <td data-bbox="407 676 690 919">Keypad</td> <td data-bbox="690 676 1433 919">The keypad is on the right side of your Surface Hub, above the pen dock. Use it to set screen brightness (3) and volume (4). See Keypad under Interacting with Surface Hub, below. The keypad also has the power button (1) and source selector (2).</td> </tr> <tr> <td data-bbox="407 919 690 1140">USB 3.0 port</td> <td data-bbox="690 919 1433 1140">Use the USB 3.0 port—(5) on the keypad—to load files onto your Surface Hub for your meeting.</td> </tr> </table>	Keypad	The keypad is on the right side of your Surface Hub, above the pen dock. Use it to set screen brightness (3) and volume (4). See Keypad under Interacting with Surface Hub , below. The keypad also has the power button (1) and source selector (2).	USB 3.0 port	Use the USB 3.0 port—(5) on the keypad—to load files onto your Surface Hub for your meeting.
Keypad	The keypad is on the right side of your Surface Hub, above the pen dock. Use it to set screen brightness (3) and volume (4). See Keypad under Interacting with Surface Hub , below. The keypad also has the power button (1) and source selector (2).				
USB 3.0 port	Use the USB 3.0 port—(5) on the keypad—to load files onto your Surface Hub for your meeting.				

Wake / sleep

When someone enters the room, Surface Hub wakes up and displays the Welcome screen. When it stops detecting movement, it goes to sleep.

NOTE If your Surface Hub seems to be asleep when you're in the room or does not respond as expected, try the following:

- On the keypad on the side of your Surface Hub, press the Source button  to toggle through the possible video input sources.
- Swipe up from the bottom of the screen. If a menu appears, select Exit Full Screen .

For more info, see [Welcome screen](#), below.

Interacting with Surface Hub

You can interact with your Surface Hub in several ways:

- [Touchscreen](#)
- [Keypad](#)

- [Keyboard](#)

You can use your Surface Hub as a display for your laptop, tablet, or smartphone. See [Connect](#), below.

Touchscreen

Surface Hub is designed for touch. Start a meeting, invite more people to join you, open apps, write on the whiteboard, send the results of the meeting to yourself and others—you can do it all with touch. When you need to enter text, a touch keyboard appears.







Several people can use the touchscreen at once.

- In pen mode, three pens can write on the whiteboard at once. For more info, see [Whiteboard](#), below.
- Touch mode supports up to 100 touch points at once. Use touch to write on the whiteboard and select items in any app.

To switch between pen and touch mode, select the **Touch/Pen toggle**  at the bottom of the screen.

Keypad

The keypad is on the right side of your Surface Hub. It has these buttons:

Icon	Description
	Power: Turns Surface Hub on or off. You'll rarely need to do this. Surface Hub automatically goes to sleep when it detects no activity in the room and wakes up when someone enters.
	Source selector: Cycles through all video input sources—onboard computer, DisplayPort, HDMI port, and VGA port
	Brightness up: Increases screen brightness
	Brightness down: Decreases screen brightness
	Volume up: Increases volume
	Volume down: Decreases volume

Keypad indicator lights

LEDs on the keypad indicate your Surface Hub's power state:

LED	Indicates
Off	No power to your Surface Hub

White	Power is on
Amber	Power is off
Flashing amber	Surface Hub has encountered a problem

Pen indicator lights





LED	Indicates
White	Sleep
Amber	Low battery
Flashing amber	Very low battery
Off	Deep sleep

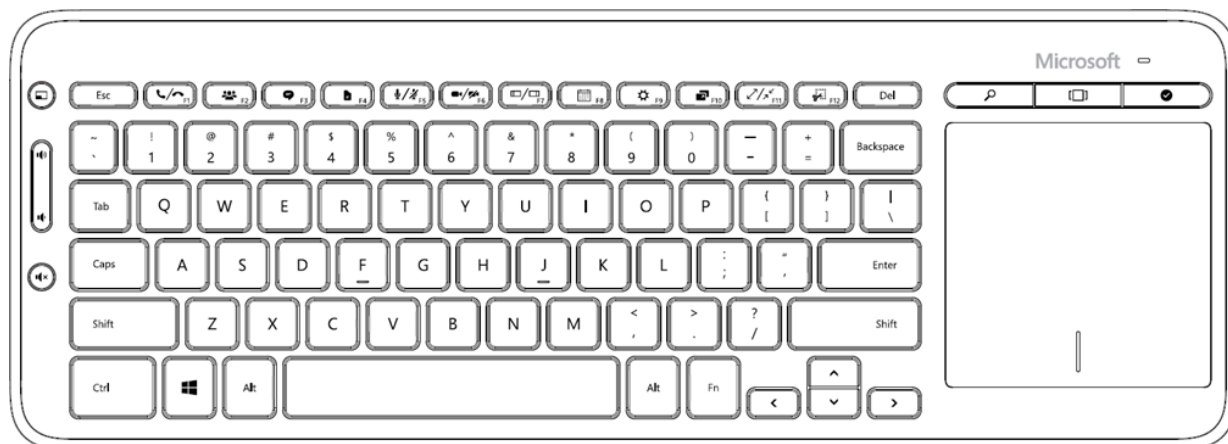





Keyboard

Surface Hub comes with a wireless keyboard that has a touchpad as well as special keys on the top row, down the left side, and above the touchpad.

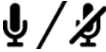
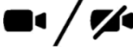
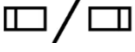



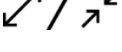

Keys on top row



Icon	Description
	Dial/Hang up: Begin or end a Skype for Business call
	People/Add a person: Opens the people pane
	Messaging: Opens the messaging sidebar
	Content: Opens the content pane

Icon	Description
	Mute/Unmute mic: Toggles to mute and unmute the microphone
	Privacy mode: Toggles to turn the cameras on and off
	Swap sidebar: Moves the sidebar to the opposite side of the screen
	Room calendar: Toggles the room free/busy calendar
	Action center: Opens the action center
	Screen sharing: Toggles to present your screen to other participants or stop presenting it
	Full screen / exit full screen: Toggles the active app in and out of full-screen mode
	Send to whiteboard: Takes a screenshot of the selected app and pastes it to the whiteboard

Keys on left side

Icon	Description
	Left click: Like the left-click button on a mouse
	Volume up: Increases volume
	Volume down: Decreases volume
	Mute: Mutes speakers

Keys above touchpad

Icon	Description
	Search: Launches Search in Microsoft Edge.
	Task view: Lets you choose between open apps or close apps
	End session: Starts the countdown for ending a session—like tapping I'm done on the touchscreen.



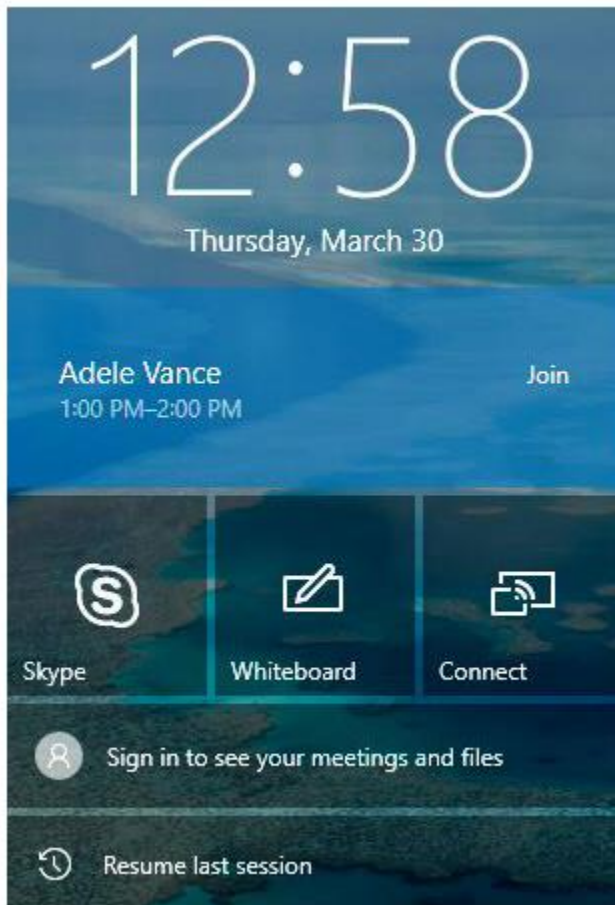

Welcome screen

The Welcome screen appears when your Surface Hub wakes up. When you close a session, your Surface Hub resets itself and the Welcome screen reappears.













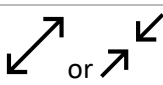







- To join a scheduled meeting, select it from the list on this screen.
- Ability to access your meetings and files directly.
- If the previous meeting is still active, select **Resume** to reopen it. You'll need to close the previous meeting before you can start a new one.
- To start an ad-hoc meeting, select one of these icons:

Icon	Description
	Skype: Starts a meeting by inviting remote participants to join, using Skype for Business

	Whiteboard: Launches the Whiteboard app. You can also open the whiteboard by taking a pen from its dock. See Whiteboard , below.
	Connect: Projects your laptop, tablet, or smartphone screen to your Surface Hub. See Connect , below.
	Sign in: Users can sign in to Office 365 to get access to their meetings and files.
	Resume last session: Lets you rejoin a meeting that is still in progress.

Icons you'll see during a meeting

Icon	Location	Description
	Bottom center	Start: Displays the All apps list and frequently used apps like Word or PowerPoint.
	Bottom center	Task view: Shows all active tasks on Surface Hub and allows you to switch between them, place two of them side by side, or close them.
	Upper right	Full screen: Expands the current window to fill the screen Exit Full Screen: Swipe up from the bottom of the screen, then select this icon.
	Either side	Call: Adds the first remote participant to an ad-hoc meeting. During a scheduled meeting, or when a meeting already has remote participants, you see additional icons. For more info, see During the meeting , below.
	Bottom center	End session: Ends the session. You'll be prompted to save files and session content.
	Top left or right	Swap side: Move the Skype for Business Call menu to the left or right side.
	Top left or right	Minimize: Minimize the Skype window.
	Top right	Clip: Places a screenshot of the current page onto the whiteboard. You can then mark up the screenshot.

Icon	Location	Description
	Either side	People: Shows the people participating in the Skype for Business call.
	Either side	Messaging: Displays IM conversations among participants.
	Either side	Content: Shows the list of documents that have been uploaded to the meeting space.
	Bottom right	Notifications: Shows notifications that have come in—like the Action center on your PC running Windows 10—and shows upcoming meetings.
	Bottom right	More: Displays additional icons: <ul style="list-style-type: none">  Do not disturb  Volume  Restart  Ease of Access
	Bottom right	Email: Select at any time during a meeting to send all the meeting notes to that point to any recipient. See Save your data , below.
	Bottom right	Skype for Business: Only visible when Skype window is minimized.

Start screen

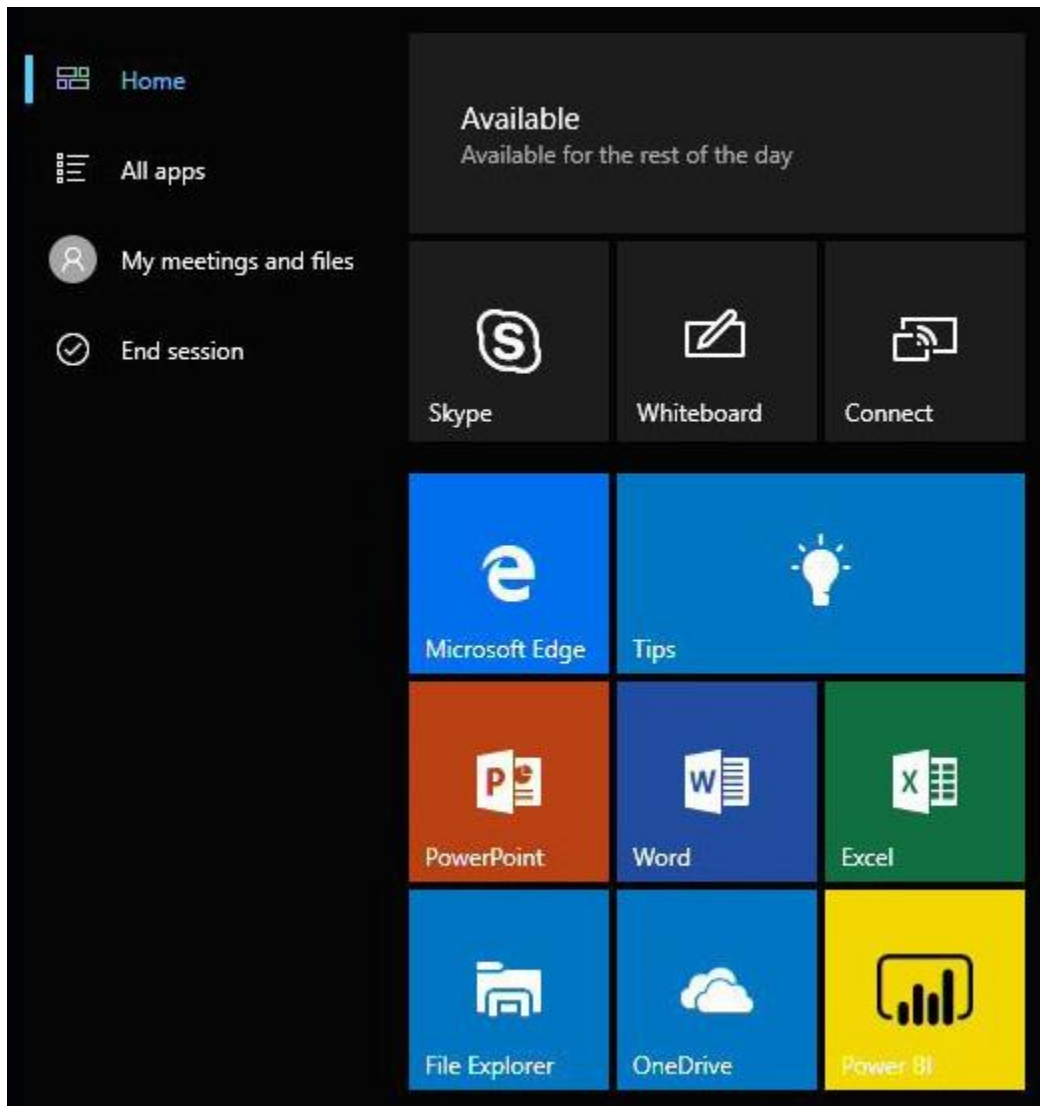

At any time, you can go to the Start screen to access the whiteboard, start a call, open apps, and more. Here's how:

- At the bottom of the screen, select **Start** .

- or -

- Press the Start  key on the keyboard.

Open an app

Select a commonly used app like Word or Excel from the tiles on the Welcome screen.

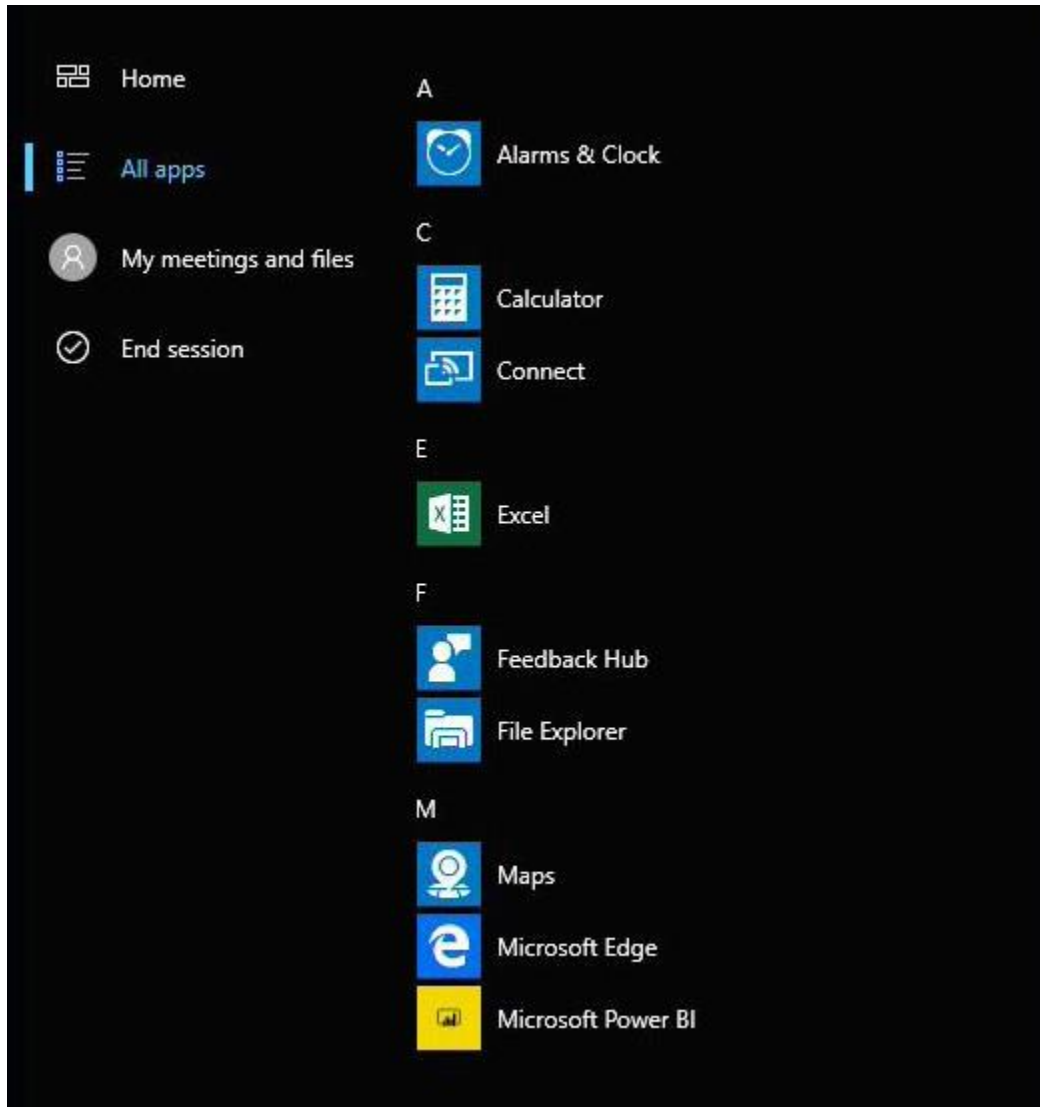

Or, select Start  > **All apps** and select the app you want.

Switch or close apps

Select **Task view**  at the bottom of the screen and select the app you want.

My meetings and files

Sign in and have full access to personal meetings and your most recently used documents, integrated right into Start.

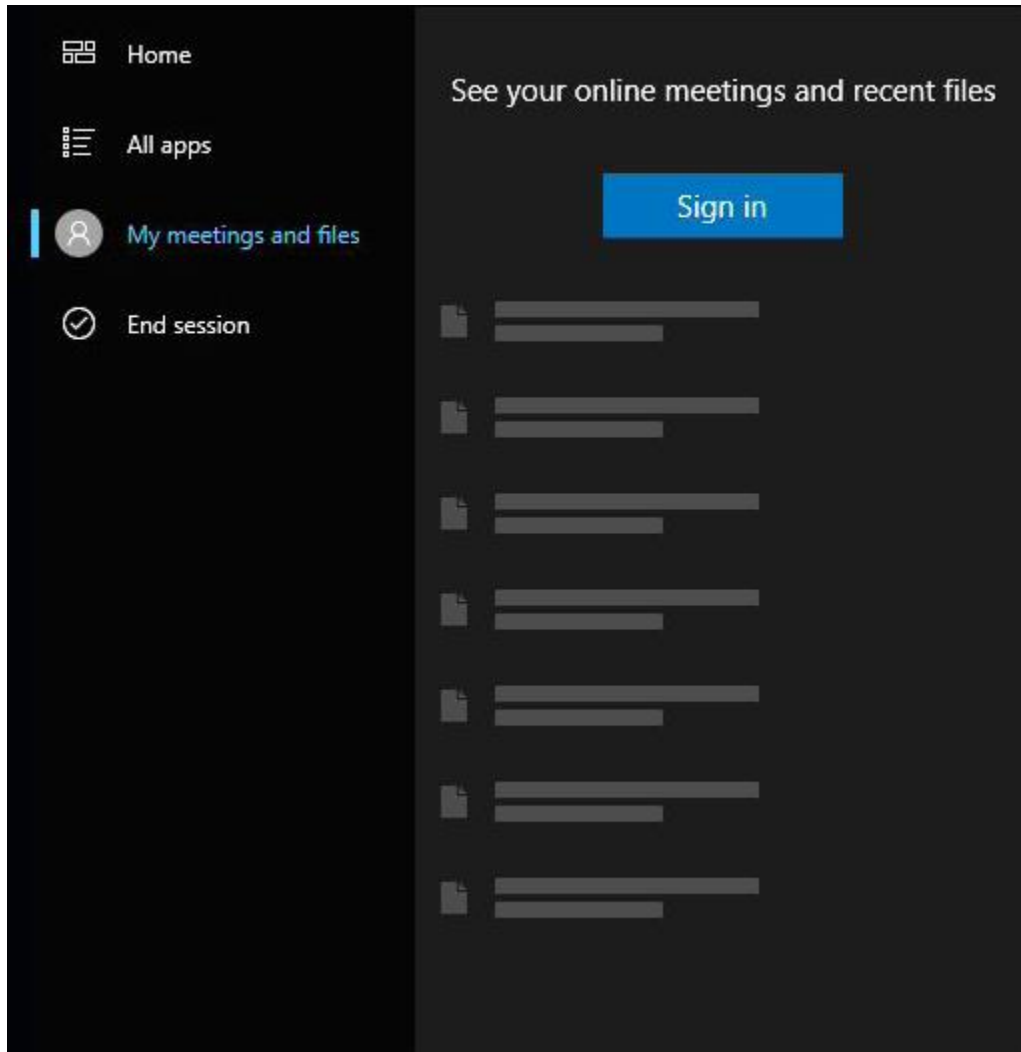

Tips app

The Tips app is a great way to get up to speed anytime. Consult it anytime you're stuck, or to learn more about Surface Hub features.

To open the Tips app, select **Start**  > **Tips**.

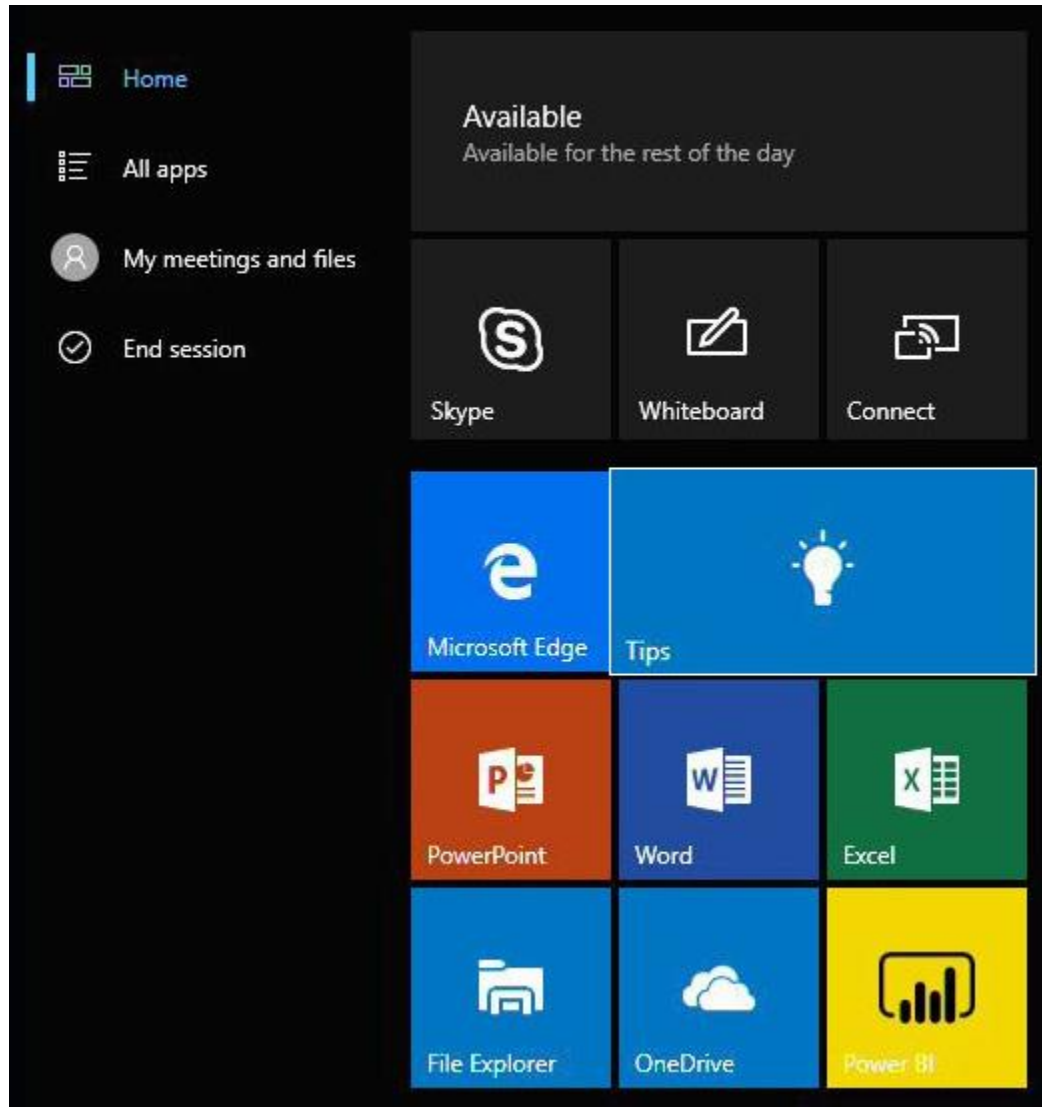

Whiteboard

Whiteboard lets people ink, ideate, and collaborate for brainstorming, diagraming, and annotating on top of content. To begin using Whiteboard, simply remove a pen from its docking station to open Whiteboard or select Start > Whiteboard.







You can also switch to Fingerprint Mode and write with your finger. Whiteboard settings like ink color, selection tool (lasso), and erase apply to everyone working at the whiteboard.

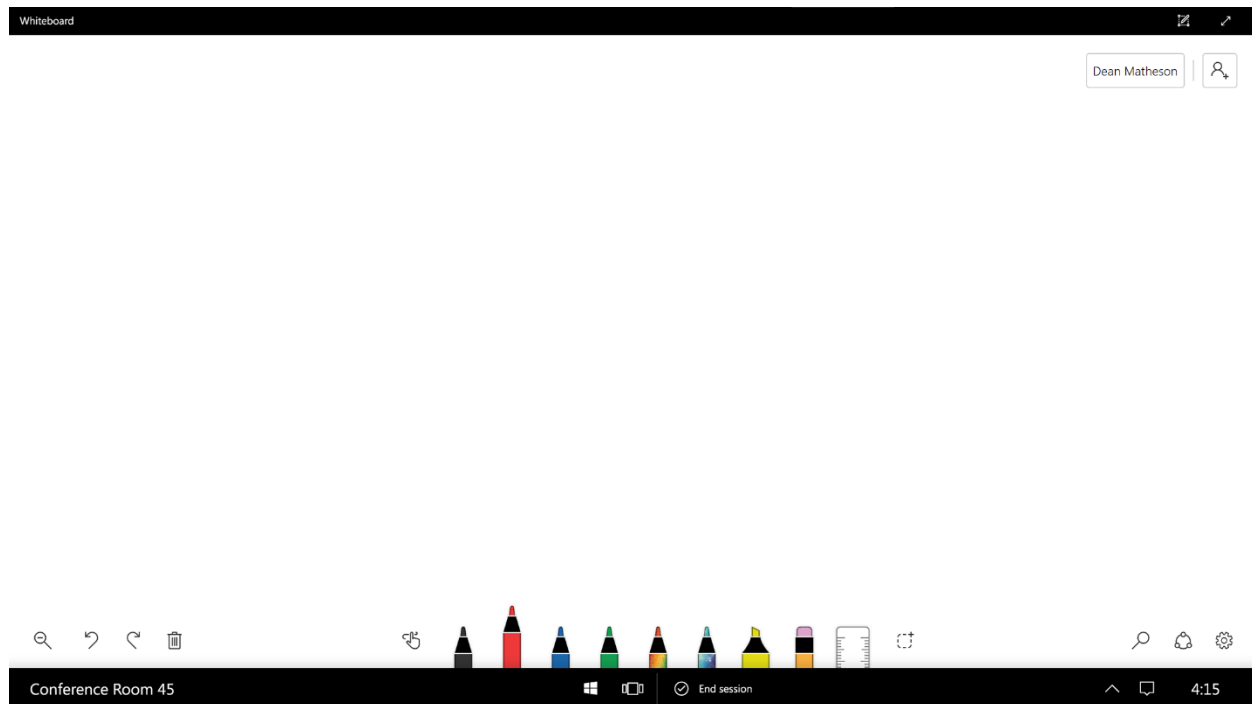



NOTE This guide applies to the version of the existing Whiteboard app that comes installed on Surface Hub and is pinned to the Welcome screen. For help with the new version of the Whiteboard app, released on July, 12, 2018, see the [Microsoft Whiteboard Help article](#). To learn more about rolling out the new version for your Surface Hub, see this [Microsoft Whiteboard Surface Hub opt-in article](#).







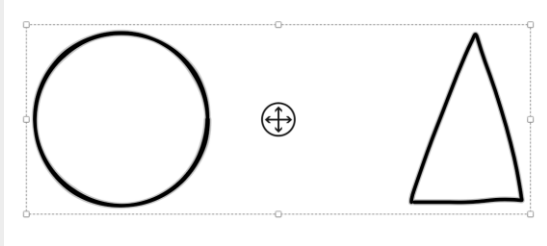

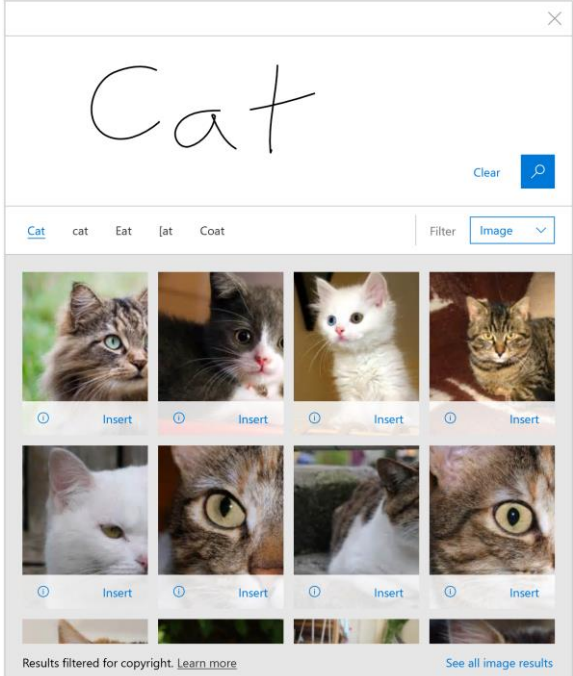

Whiteboard menu

The menu is at the bottom of the whiteboard screen.



Icons	Description
	<p>Bird's Eye View: Tap to see a zoomed-out version of the current whiteboard. You can then select with the pen or your finger any content and place it around the canvas. You can also tap to zoom in to that location.</p>
	<p>Undo: Tap to undo the last action. Note: this action is unavailable during a collaboration session.</p>
	<p>Redo: Tap to redo the last action. Note: this action is unavailable during a collaboration session.</p>
	<p>Trash: Erase everything on the whiteboard. Note: this action is unavailable during a collaboration session.</p>
 <p>(inactive) (active)</p>	<p>Fingerprint Mode: Switch between using pen (fingerprint inactive) and touch (fingerprint active) for inking, erasing, and highlighting.</p>
	<p>Color: Select black, red, blue, green, rainbow, galaxy, and highlighter colors. The color you choose applies to touch or pen marks from all participants. A raised pen indicates which color you're using.</p> <p>Note: Highlighter appears on top of other colors so it doesn't mask them.</p>

	<p>Erase: Erase content using touch or a pen. When Erase is selected, the tip of the pen works as an eraser. At any time, you can still use the flat end of a pen as an eraser.</p>
	<p>Ruler: Tap the Ruler to enable it and then use your fingers to position it on the screen. Once positioned, use a pen (or your finger (if in Fingerpaint Mode)) to draw straight lines along the edges of the ruler.</p> <p>Note that you can use three fingers to pivot the Ruler in 5 degree increments.</p>
	<p>Lasso: Circle an area to select all the images within it. Images that are entirely inside the lassoed area are outlined in gray and defined by a box.</p> <div data-bbox="704 722 1247 966" data-label="Image">  </div> <p>Select and drag any corner of the selected area to resize the image.</p> <p>Select Move  and drag it to relocate the lassoed section.</p> <p>Press and hold a lassoed section with a pen or finger to cut or copy a lassoed image or to paste an image from the clipboard</p>
	<p>Search: Tap to write in a search term and see images related to that term. Whiteboard uses Bing Image Search with Safe Search set to Strict.</p> <p>The first set of results are images with a Creative Commons license for reuse. You can see additional results by tapping See all image results:</p>

	 <p>Using Bing Image Search in Whiteboard requires that you agree to privacy terms.</p>
	<p>Share: Tap to reveal the share charm so you can email an image and a .one file of the whiteboard or save it to your OneDrive.</p>
<ul style="list-style-type: none">  Ink to Shape <input checked="" type="checkbox"/> On  Ink to Table <input checked="" type="checkbox"/> On  Show Angles on Shapes <input checked="" type="checkbox"/> On  Send Feedback >  Privacy Options >  About >  Help > <div style="text-align: right; margin-top: 10px;"></div>	<p>Ink to Shape automatically converts simple shapes like triangles, circles, rectangles, and more to clean, tidy ones.</p> <p>Ink to Table automatically converts a rectangle bisected with horizontal or vertical lines into a table with columns and rows that you can fill with ink or other information.</p> <p>Show Angles on Shapes requires that Ink to Shape be enabled and allows you to tap on shapes to see the angles for each vertex. You can adjust the angles by dragging the corner of the shape.</p> <p>Gear: Tap to set default smart ink options like Ink to Shape, Ink to Table, and Show Angles on Shapes.</p> <p>You can also send feedback via the Feedback Hub, turn on or off privacy options for Bing Image Search or view more information about the application.</p>
<div style="border: 1px solid gray; padding: 5px; display: inline-block;">Sign in</div>	<p>Sign in: Tapping Sign in allows you to initiate a collaboration session with other Surface Hubs if your organization is using Office 365, has OneDrive for Business</p>

	<p>deployed, and is not using <i>Office 365 Germany</i> or <i>Office 365 operated by 21Vianet</i>.</p>
	<p>Collaborate: Tapping the button next to your name allows you to generate a collaboration link and share it with others on Surface Hubs so they can collaborate on the same whiteboard as you.</p> <p>Please note that this button only appears if your account can leverage the Whiteboard collaboration feature. If you believe you should be able to collaborate but don't see the button, please contact your IT administrator.</p>

Smart Ink

Whiteboard includes smart ink features that help you write, draw, and work together more efficiently.

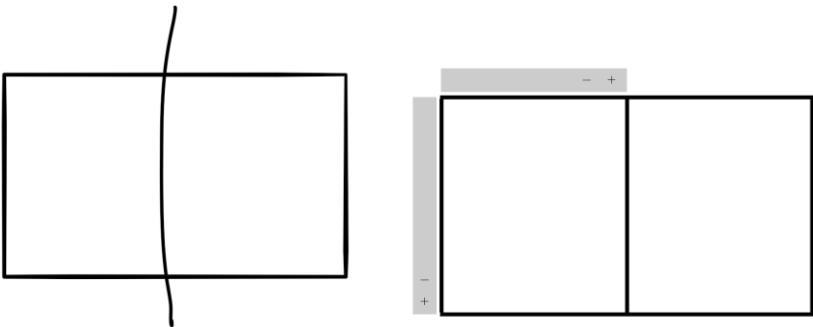
Feature	Description
<p>Ink to Shape</p>	<p>With Ink to Shape enabled, all simple shapes including triangles, circles, rectangles, and other polygons drawn by hand will automatically be cleaned up into straight-lined shapes.</p>
<p>Ink to Table</p>	<p>With Ink to Table enabled, you can create tables on the canvas that have rows and columns so you can more easily collect and work with data in whiteboard.</p> <p>To create a table, first draw a rectangle or square (with or without Ink to Shape enabled). Then draw a straight vertical or horizontal line that fully bisects the rectangle or square. Horizontal lines create new rows and vertical lines create new columns.</p> <div style="text-align: center;">  </div> <p>Once you've created a table, you can also add and remove columns or rows by tapping on a row or column and pressing the + or – buttons to remove/add. You can also highlight cells by inking with the highlighter anywhere within a cell. Highlighting the cell again removes the highlight.</p>
<p>Shown Angles on Shapes</p>	<p>To use Show Angles on Shapes, you must have Ink to Shape enabled and have a shape with angles recognized (circles won't work). Once you have a recognized shape and made sure you have Show Angles on Shapes enabled, tap on the shape to see the angles for that shape. You can grab the vertices of the shape to change the angles:</p>

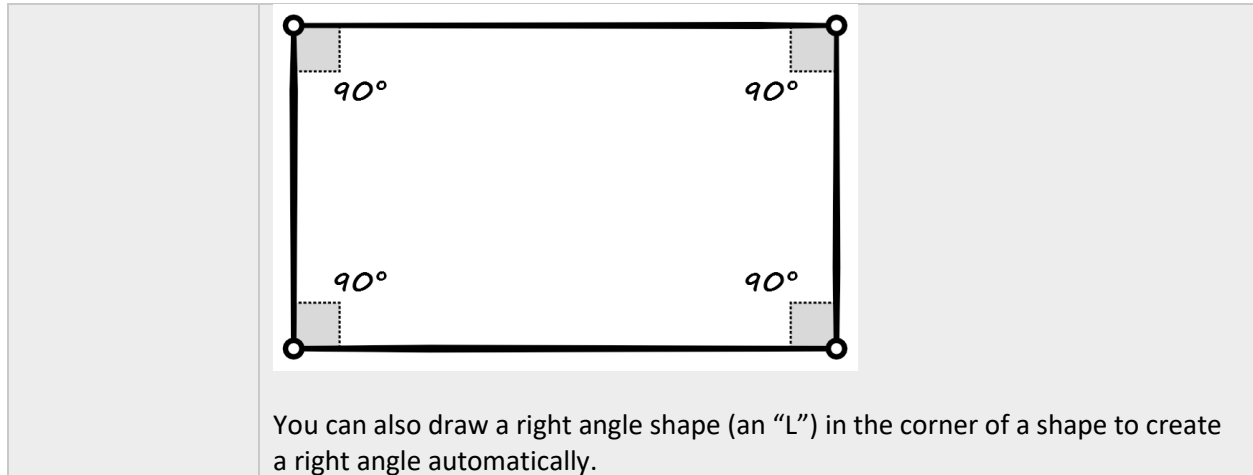

Whiteboard to Whiteboard collaboration

Whiteboard now allows you to remotely collaborate with other users on the same whiteboard so you can ink, work, and collaborate in real time.

To use Whiteboard to Whiteboard collaboration, you need to make sure that your organization and Surface Hub meet the following requirements:

- Office 365 with cloud-based Azure Active Directory (Azure AD) for all users
- OneDrive for Business deployed for all users who intend to collaborate
- Currently not utilizing Office 365 Germany or Office 365 operated by 21Vianet
- Surface Hub needs to be updated to Windows 10, version 1607 or newer

If you have questions, reach out to your IT administrator for more information.

To start a collaboration session:

1. In the Whiteboard app, tap the **Sign in** button.
2. Sign in with your organization ID.
3. Tap the **Invite** button next to your name at the top of the app.
4. Tap **Start session**. Whiteboard will generate a link that you can share.

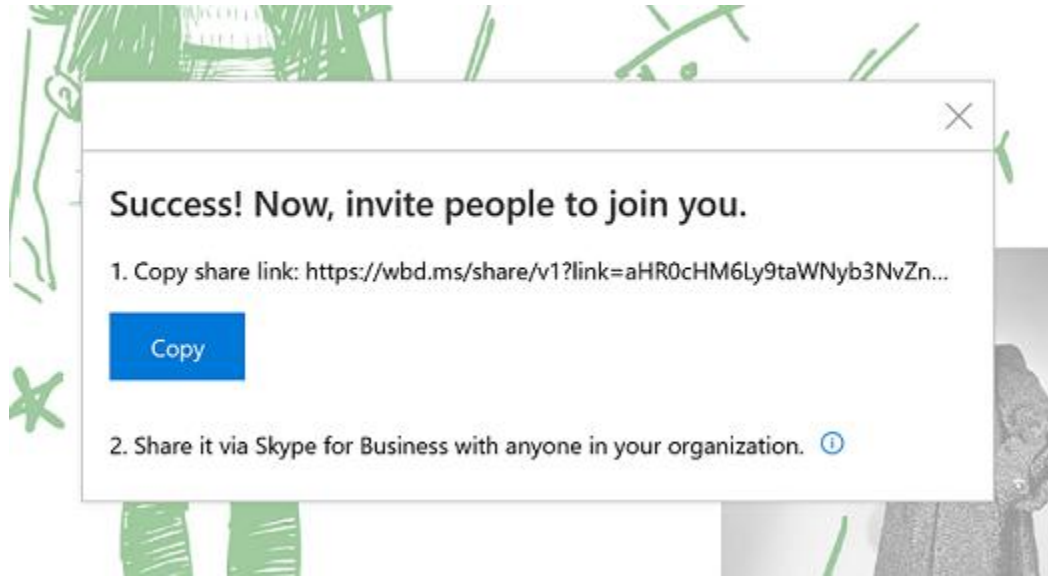

5. Copy and paste this link into a Skype chat with another Surface Hub

When the other Surface Hub receives the link, the recipient can tap on the link, sign in to Whiteboard, and then begin collaborating. You can copy and paste other content, use smart ink features like Ink to Shape, and co-author together.

After you're done, you can export a copy of the Whiteboard collaboration for yourself through the Share charm and leave the board for others to continue working.

Connect



Use the Connect feature to project the screen and audio from your laptop, tablet, or phone to your Surface Hub. Connect supports these special features:

- **Touchback:** Lets you control your connected laptop, tablet, or phone from the Surface Hub touchscreen.
- **Inkback:** When you project an app that supports inking to Surface Hub, any markups done on the Surface Hub screen appear in the file on the device you're using to project. For example, if someone circles a paragraph in a Word doc on the Surface Hub screen, that circle appears in the file on the tablet you used to project the file. If you save the file on the tablet, you also save the circle around the paragraph.

Connections can be wireless or wired.

Wireless Connect

If your phone, laptop, or tablet supports Miracast, you can project your screen wirelessly to your Surface Hub. Here's how, if you're using Windows 8 or later:

1. Press the Start key +K or open the **Action center**  and select **Connect**.
2. Select the name of your Surface Hub from the list that appears.

3. If prompted, enter the PIN that appears on the touchscreen.

For other types of devices, check the manufacturer's website for instructions.

Wired Connect

If your system admin has set up a wired connection to the Surface Hub, you can connect by plugging a cable into your laptop or tablet.

- Plug in the video cable that works with your device (DisplayPort, HDMI, or VGA).
- If you want to use Touchback and Inkback, plug in the USB 2.0 cable.
- If you're using a VGA cable and you want to include audio, plug in the 3.5mm audio cable.

Conduct a meeting

All activities and sessions on your Surface Hub are considered meetings, either ad-hoc or scheduled. Aside from scheduling, there's no difference between them. All of your Surface Hub's features and applications are available in both.

You can use Skype for Business to invite remote participants during any meeting. See [Add participants during a meeting](#), below.

NOTE To join a meeting with Surface Hub, remote participants may need to download software and set up an account to use Skype for Business. For details, see [Skype Downloads](#) on [skype.com](#).

Your meeting session stays open until you close it, even if another meeting is scheduled after yours and you run late. At the end of a meeting, you must close the session. Be sure to email any meeting notes you want to keep before you close the session. To protect your privacy, Surface Hub deletes all the notes from your meeting when you close the session.

Start an ad-hoc meeting

You can start an ad-hoc meeting in several ways:

- Touch one of the icons on the Welcome screen.
- Press the **Start** key  on the Surface Hub keyboard.
- Connect your device to the Surface Hub using cables or Miracast.

You can then invite others to join your meeting through Skype for Business.

Start a scheduled meeting

Set up a scheduled Skype meeting in Outlook, with your Surface Hub as a participant. Remote participants can join the Skype for Business meeting using Skype for Business on another Surface Hub or their own device. PowerPoint files can be uploaded into your Skype for Business meeting and viewed by local participants on the Surface Hub, as well as by remote participants. Upcoming scheduled meetings are listed on your Surface Hub in Notifications and on the Welcome screen. To join a scheduled meeting, select it from the Surface Hub screen.

Invite people to your meeting

Schedule a meeting



Use Outlook to schedule a Skype for Business meeting that includes your Surface Hub and any remote Surface Hubs that other participants will be using.

Add participants during a meeting

To add the first person to an ad-hoc meeting:

1. Select **Call**  on either side of the screen.
2. Do one of the following:
 - Select **Search for someone**, enter the name or email address of the person you want to invite, and select the name from the list. Then select **Invite**.
The person you invite will get a pop-up invitation in Skype for Business.
 - Select **Make a phone call** and enter the number of the person you want to call.

To invite additional people to a scheduled or ad-hoc meeting:



1. Select **People** , on either side of the screen, then select **People plus** .
2. Enter the email address of each person you want to invite and select the name from the list. Then select **Invite**.
The person you invite will get a pop-up invitation in Skype for Business.

For more info, see [Skype for Business](#).

Before the meeting

You can join the meeting before it starts to get things ready. Just select the link for your meeting from the Surface Hub Welcome screen.



If the previous meeting was left running, you'll need to close it before you start your meeting. This will delete all data from that meeting. To be courteous, email the organizer's notes and data before closing.

If it was a scheduled meeting, select Email . The organizer's email address is filled in automatically. If the previous meeting was ad-hoc but you know who was using the Surface Hub, select Email  and enter the person's email address.

During the meeting

During the meeting, you can take notes and draw on the whiteboard. At the end of the meeting, send these notes to anyone who needs them as a OneNote page or a .png image file.

During a Skype for Business meeting, additional icons appear on the sides of the screen:

	<p>People: Shows the people participating in the Skype for Business call.</p>
	<p>Messaging: Displays IM conversations among participants.</p>
	<p>Content: Shows the list of documents that have been uploaded to the meeting space.</p>

Accessing content attached to meeting invite

Before an attachment is visible on the Surface Hub, the Skype for Business meeting originator must present the content while connected to the meeting. Begin by choosing **Present > Manage Content** on the meeting originator’s Skype for Business client.

Note: Pre-loading meeting attachments is a feature in Skype for Business Online only.

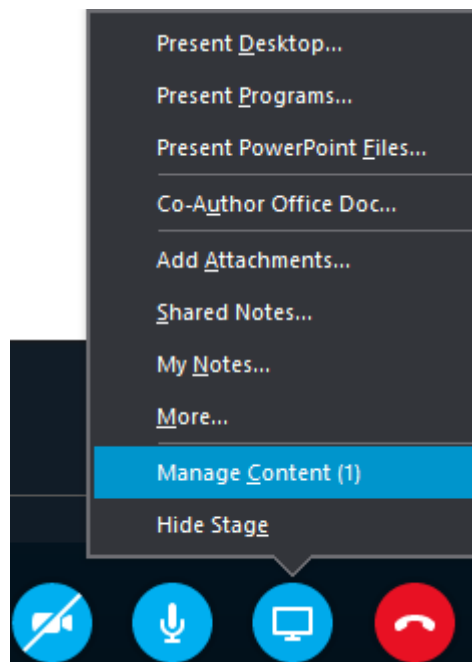

PowerPoint content that was attached to the Skype meeting invitation will be displayed. Choose the PowerPoint you would like to share and click the “Start Presenting this content” icon on the far left.

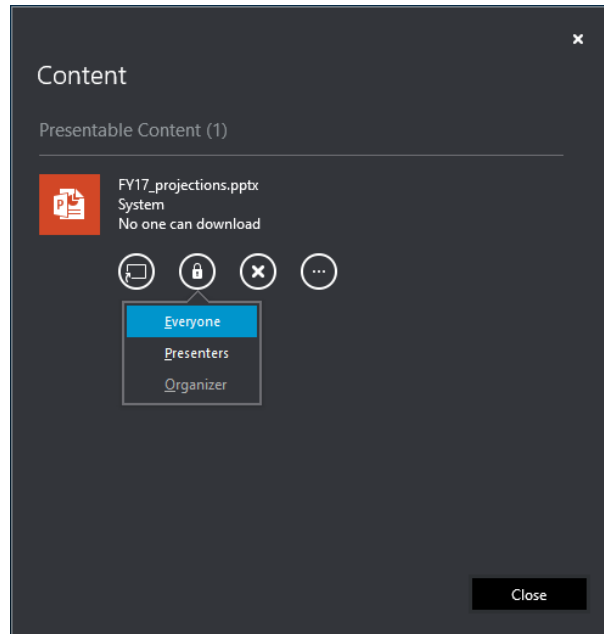

To begin displaying this content on the Surface Hub, a user must first request a pin number. This is done to protect your content from unauthorized viewing. On the Surface Hub, click **Content**  from the menu at the left or right edge of the Surface Hub screen and then choose the PowerPoint file you wish to view.

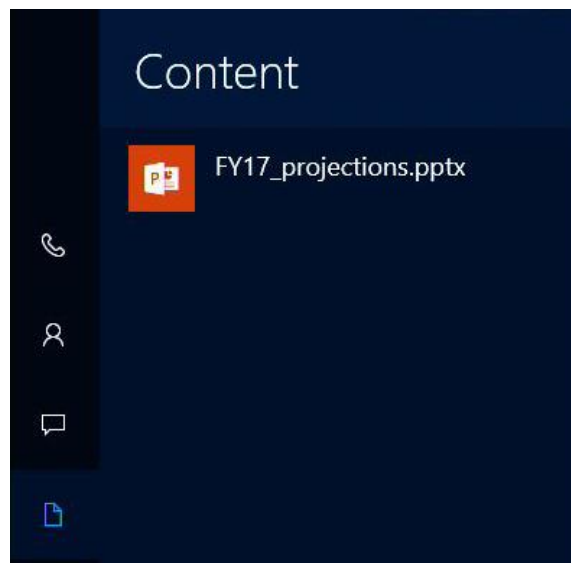

Click the "Get a Content PIN" button to request a new PIN from the content owner.

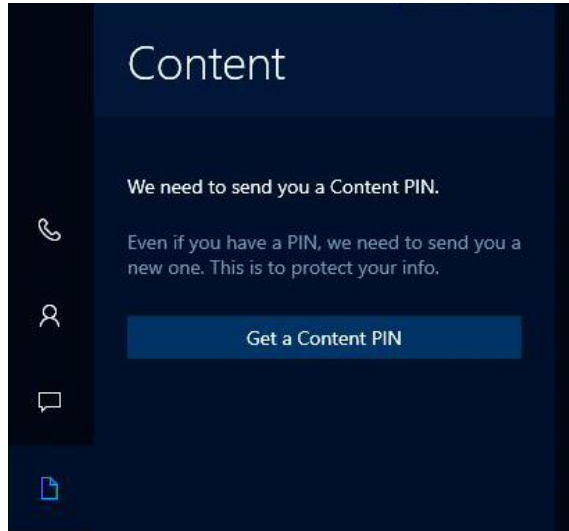

Choose the content owner member that is present and hit send. This individual should be present in the same room as the Surface Hub for quick Pin retrieval.

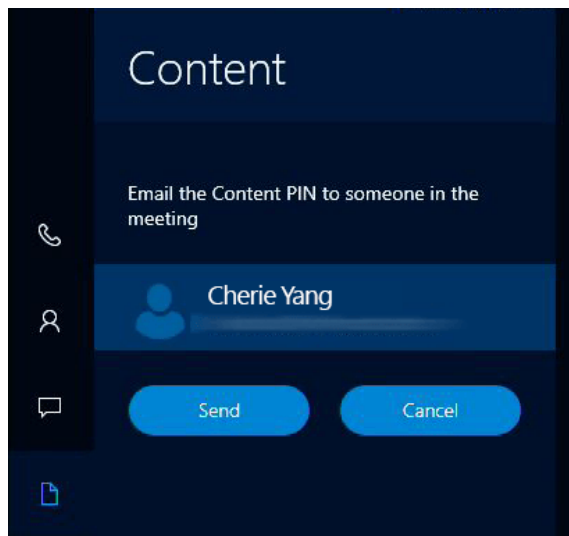

An email containing the four-digit code will be sent to this user. Once received, enter the Content PIN into the next window.

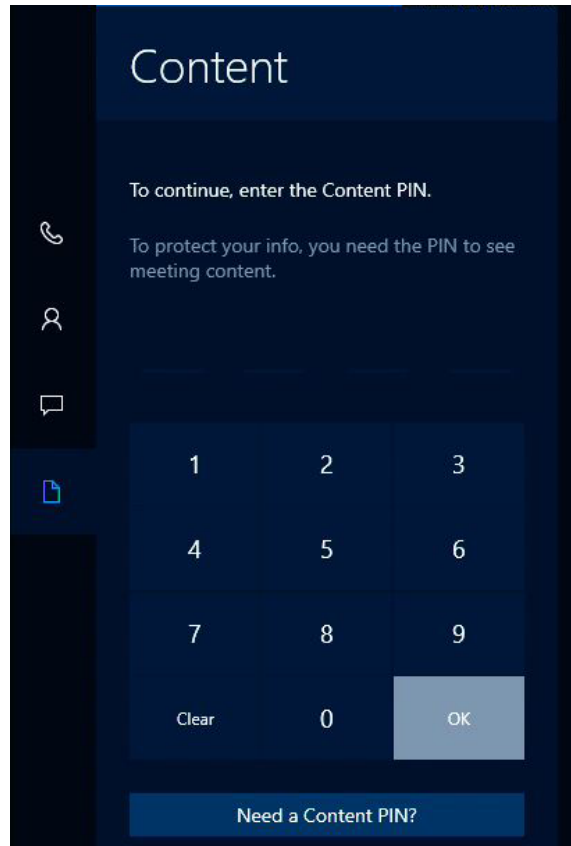

The PowerPoint file will now be presented on the display as well to the remote participants.

[Share content with remote participants](#)

Sharing your Surface Hub screen is a lot like sharing your screen in Skype for Business.

- Select **Present** to start sharing.
- Select **Stop presenting** when you're done.

[Upload content to the meeting space.](#)

Before or during a Skype for Business session, remote users can share PowerPoint files with the Surface Hub as well as all participants. Any shared files will be shown on the Surface Hub in the Content tab .

NOTE You can upload meeting attachments in Skype for Business Online and on-premises Skype for Business.

To begin sharing a file with the meeting participants click **Present**  within your Skype for Business desktop client and choose **Present PowerPoint Files**.

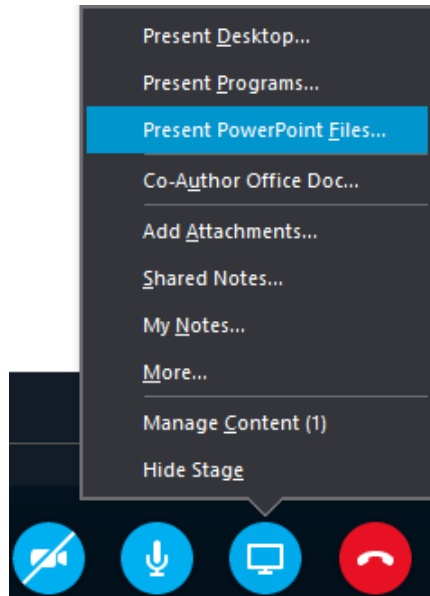

Once you have chosen your file and clicked **Open**, the file will be automatically shared and uploaded to the meeting space. Click the Content tab icon  to select the file you want to present.

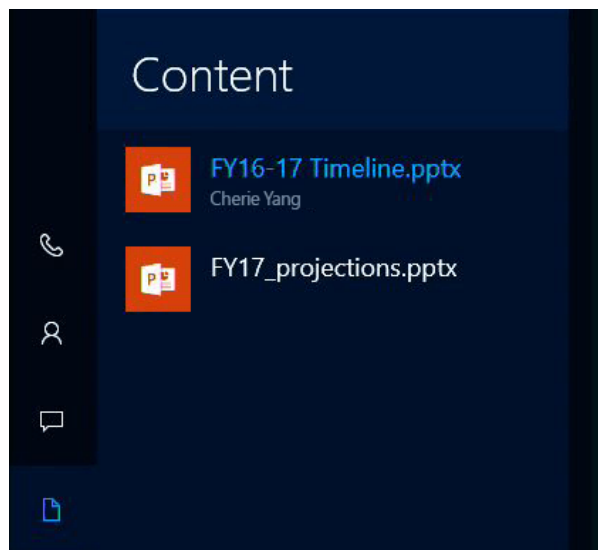

Adjust cameras, mic, and volume



During a Skype for Business session, select **Messaging** . Then choose any of the following settings:

- Active camera
 - **Automate camera settings:** Let your Surface Hub determine which camera to use. The camera will use sound and motion detection to focus on who's talking. A light appears under each camera.
 - **Left camera:** Use the left camera only. A light appears under the left camera.

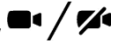
- **Right camera:** Use the right camera only.
A light appears under the right camera.
- **Camera off:** Turn off both cameras.
No light appears under either camera.

You can also turn off the cameras from the Surface Hub keyboard by pressing the **Privacy**  key.

- Microphone muting

If the mic is active, the **Microphone**  icon appears. If it's muted, the **Muted microphone**  icon appears. Do either of the following to toggle between these settings:

- On the touchscreen, select the icon to toggle between muted and active.
 - On the keyboard, press the **Microphone** key .
- Volume control setting
 - On the keypad, press one of the volume buttons.
 - On the touchscreen, slide the volume to the level you want.
 - On the keyboard, press the volume up or volume down button.

Use apps in split-screen mode

When you open a second app, it appears alongside the first app. You can open more than two apps, but only two can be displayed at once. Here's how to open more than one app.

1. Open the first app, for example the Whiteboard app or a Word doc.
2. Select Start  > **All apps** and select the second app. Repeat to open additional apps.

To hide one of the apps, drag the vertical black bar toward the app you want to hide until the app disappears.

To display the app again or change which apps are displayed:

1. Select **Task View**  at the bottom of the screen.
2. Drag the app you want to the side of the screen where you want it to appear.

Annotate

To copy an image of a page in an open document to the whiteboard and mark it up, select the document and select **Clip** .

Save your data

Be sure to save your changes before ending the meeting. How you do that will depend on which apps you used.

- Changes made to apps running on your Surface Hub, such as Whiteboard, Word, Excel, and PowerPoint, must be emailed to a person or team.
- Changes made to data on your computer and projected to your Surface Hub can be saved to your computer.

IMPORTANT Your data can be irretrievably lost after you end your meeting. Be sure you email everything, or upload it to OneNote. Here's how:

1. Select **Email**  at the bottom right of the screen.
2. Select **To:** and enter the email addresses, or select **OneDrive** and follow the steps.
3. Select **Send**.

End the meeting

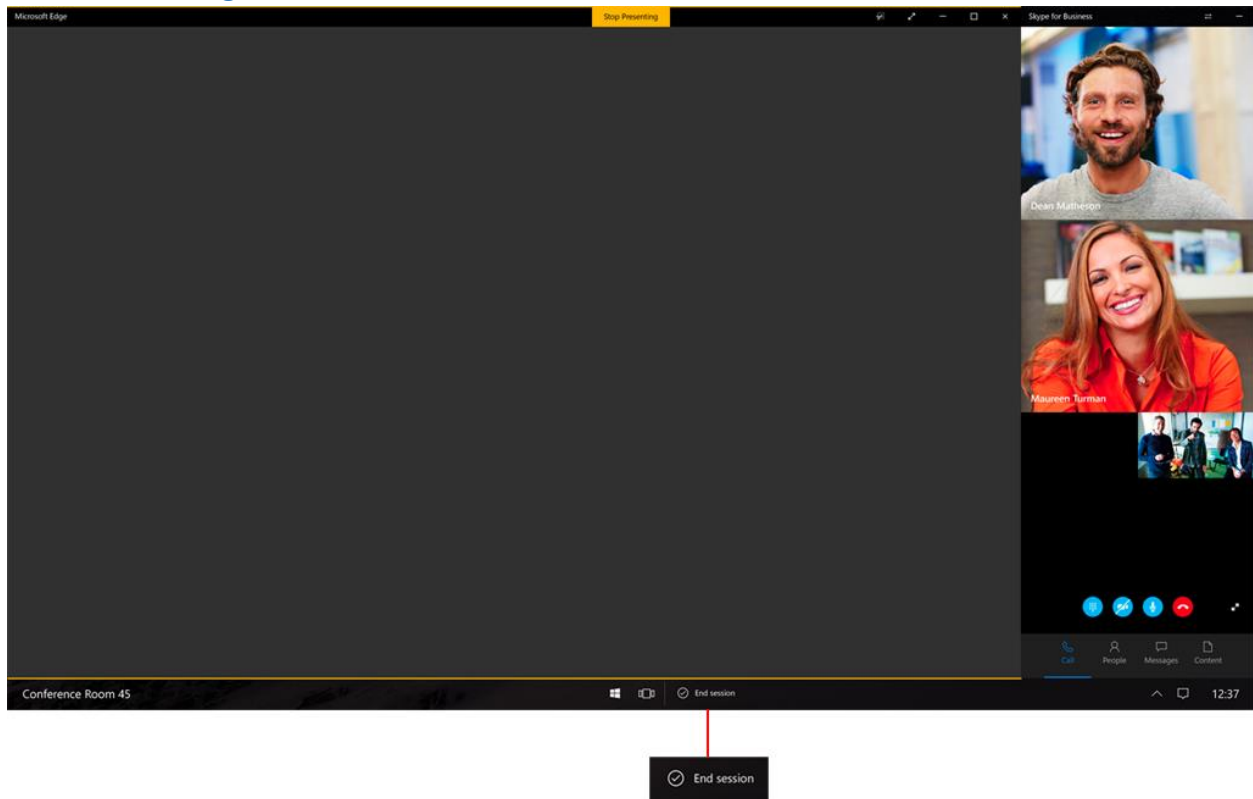

To end a meeting, select **End session** at the lower-right corner of the touchscreen or press the End session key  on the keyboard.

When you select **End session**, you'll see a brief countdown during which you can go back and save your data. This is your last chance to save any files.

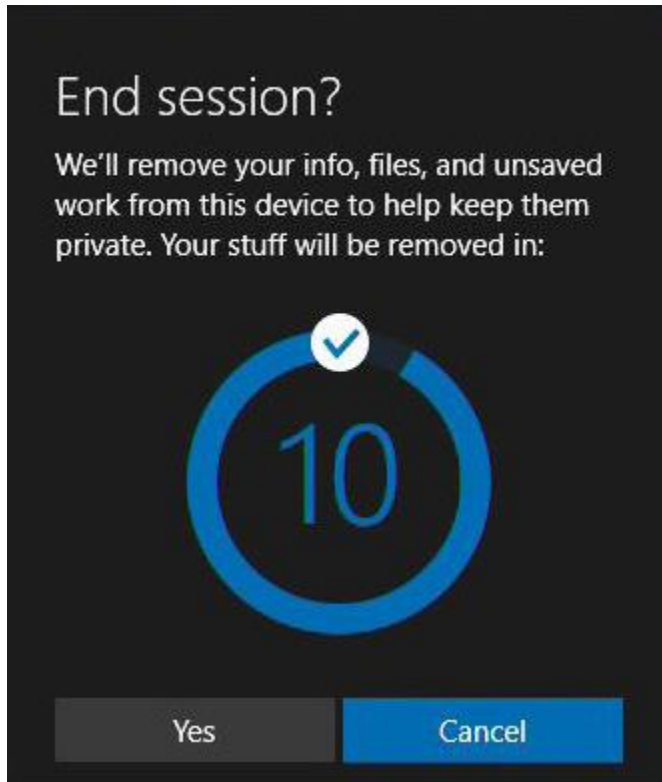

When you end your meeting:

- If you're projecting to your Surface Hub from a device in the room, that connection closes.
- If you're in a Skype for Business meeting, your Surface Hub leaves the meeting.
- Any open applications on your Surface Hub close.
- Data and files from the meeting are deleted.

NOTE Selecting **End session** closes only the local session. People using another Surface Hub can continue the meeting with all the apps still open.

What if I forget to end my meeting?

If you forget to end your meeting, the session goes to sleep but does not time out. The next time someone enters the room, the Welcome screen appears with a prompt to resume the meeting. This means that all the files and information from your meeting will be available to the next group.

The next group using the Surface Hub can email your data to you if it was a scheduled meeting or if they know you were the last one to use the Surface Hub. Or, they can just end your meeting, discarding all your session data.

Restart a meeting

If you're having problems with your Surface Hub, you can restart the meeting.

1. Email the data to yourself.

2. End the meeting.
3. Start a new meeting and load the data you saved.

If restarting doesn't solve the problem, contact your system admin.

Sign in to see your meetings and files

You can view your upcoming meetings and recently used files right from your Surface Hub. Depending on your corporate environment, there are two slightly different methods used to log into your account. [Easy Authentication method](#) uses your Android OS based phone (6.0 and higher) with the Microsoft Authenticator application to enter a unique PIN to provide access. Using a PIN isn't available? [Use your user name and password combination](#) to provide access to your meeting and files. Both options require your content to be hosted in O365 and that you are invited to a scheduled Skype for Business meeting on the Surface Hub.

Easy Authentication method

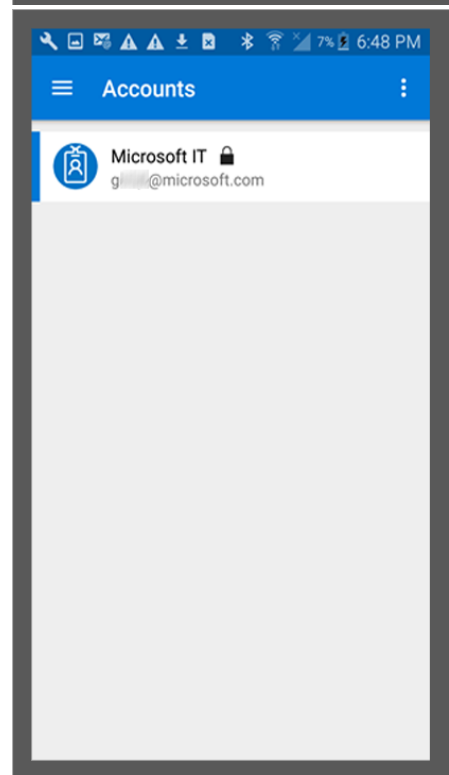
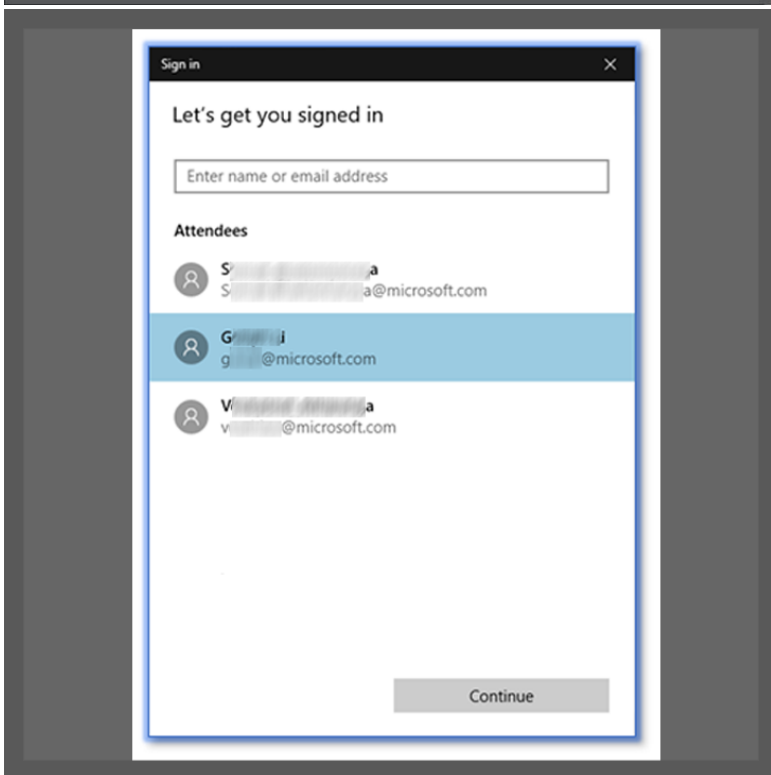
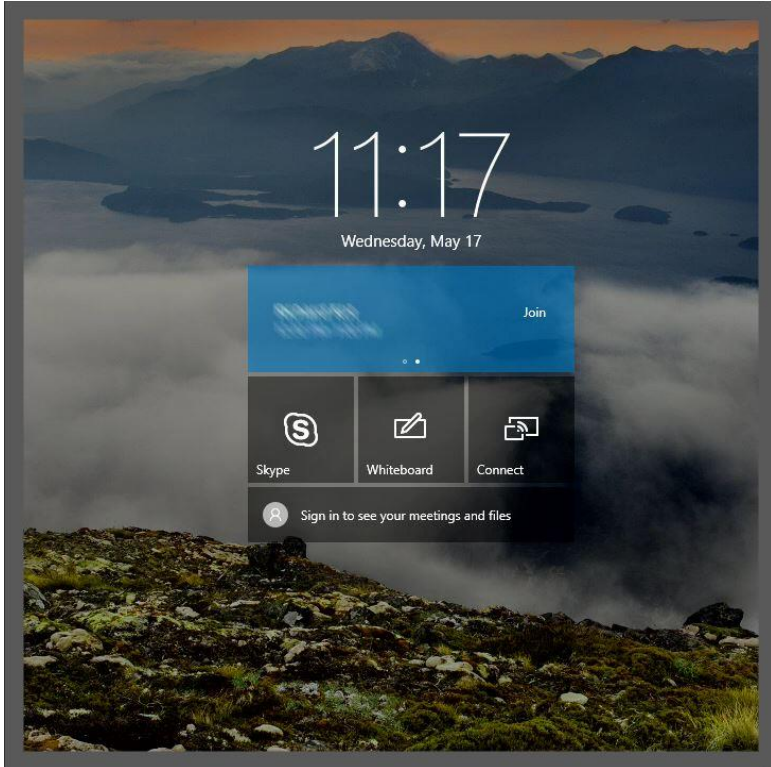

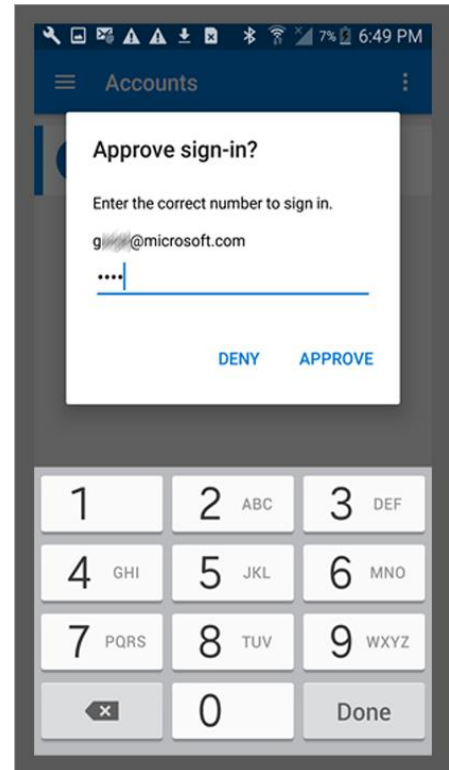
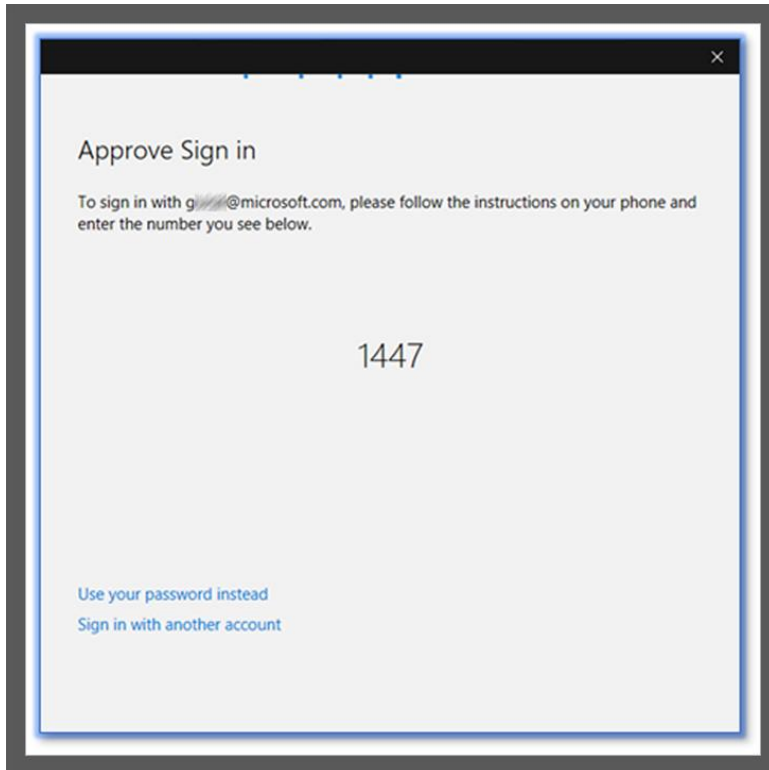
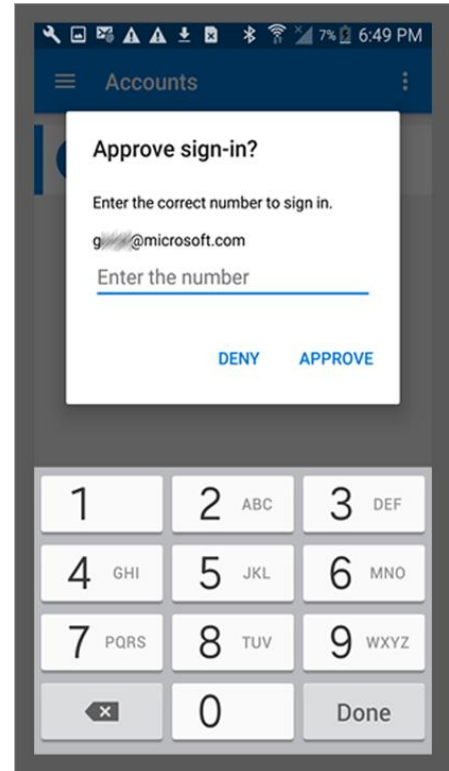
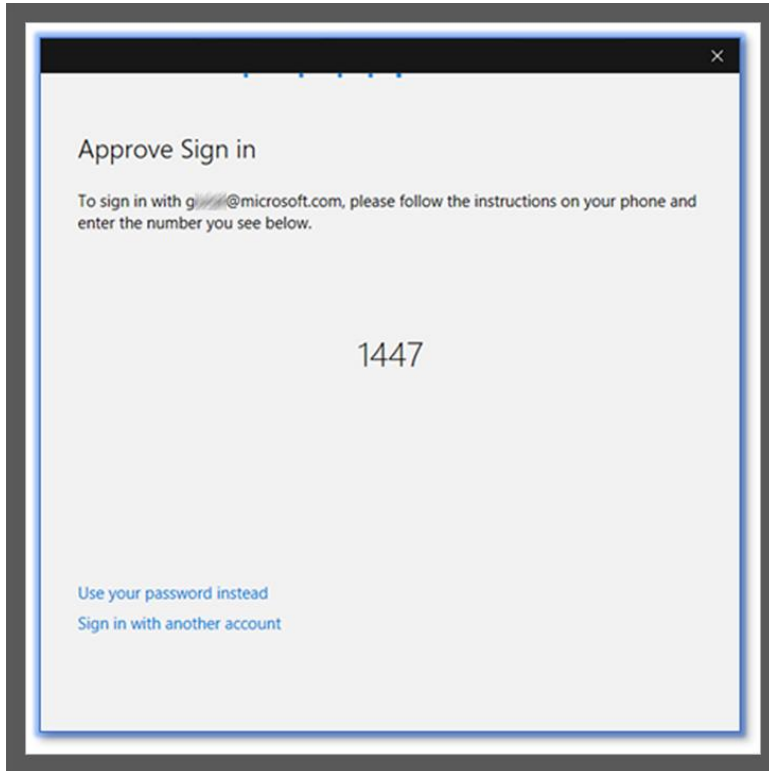

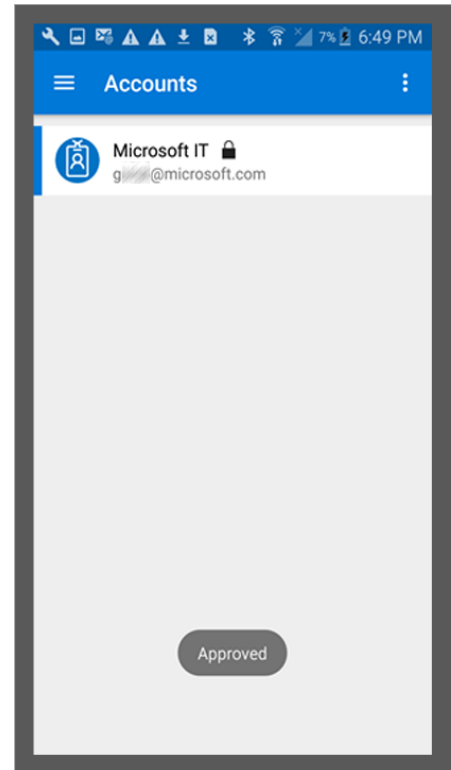
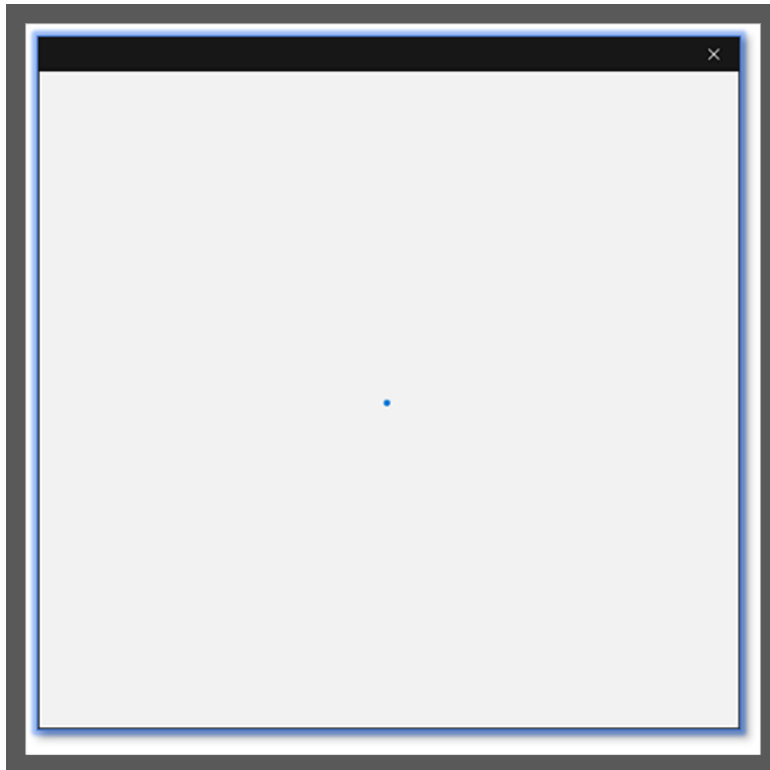
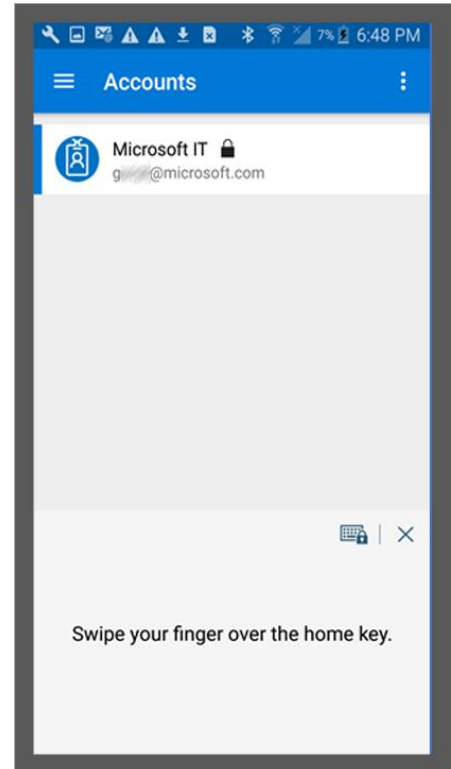
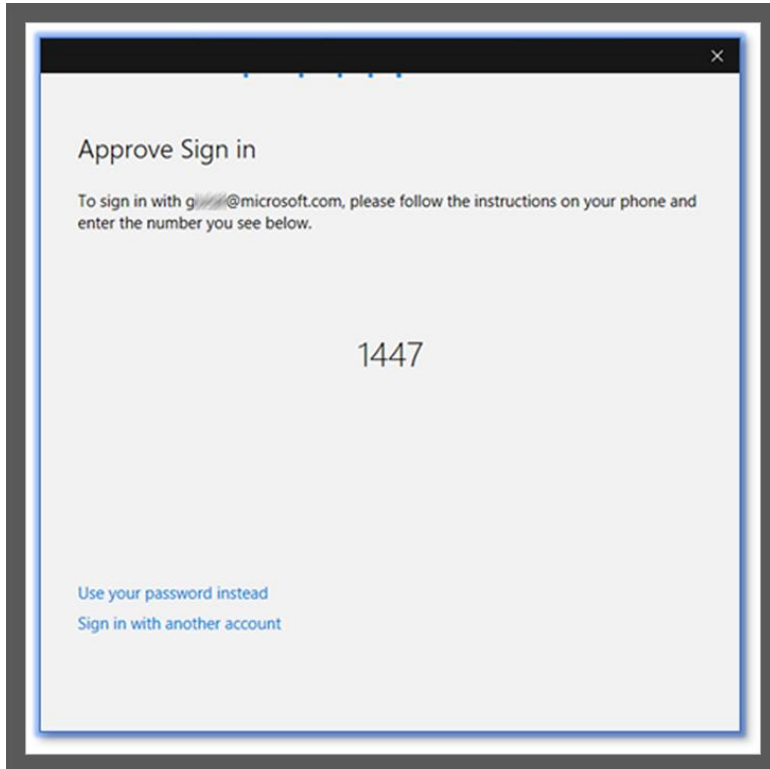

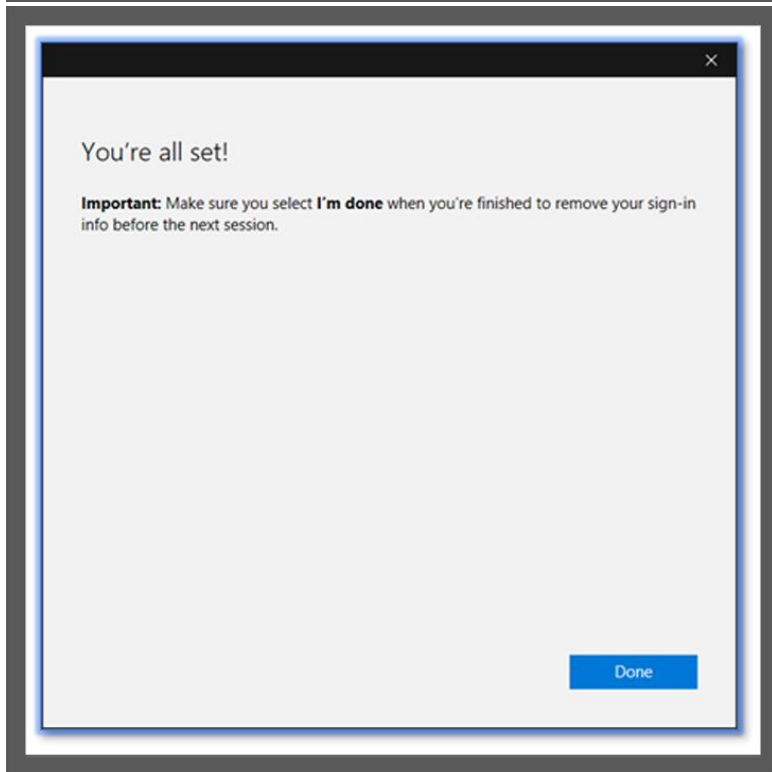
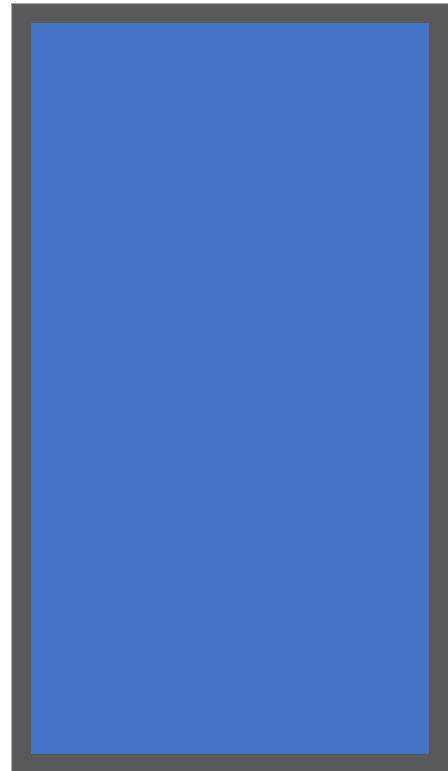
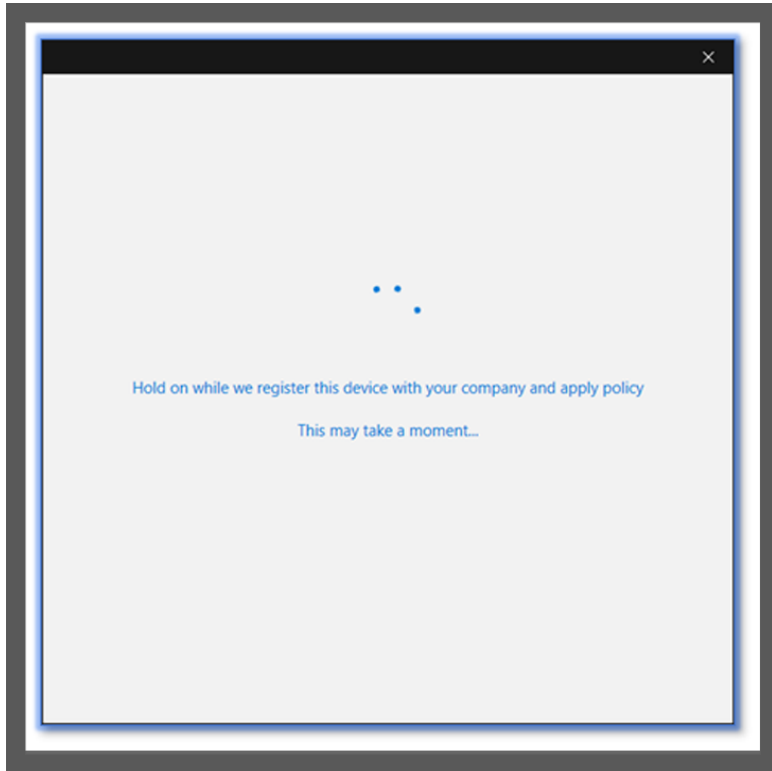

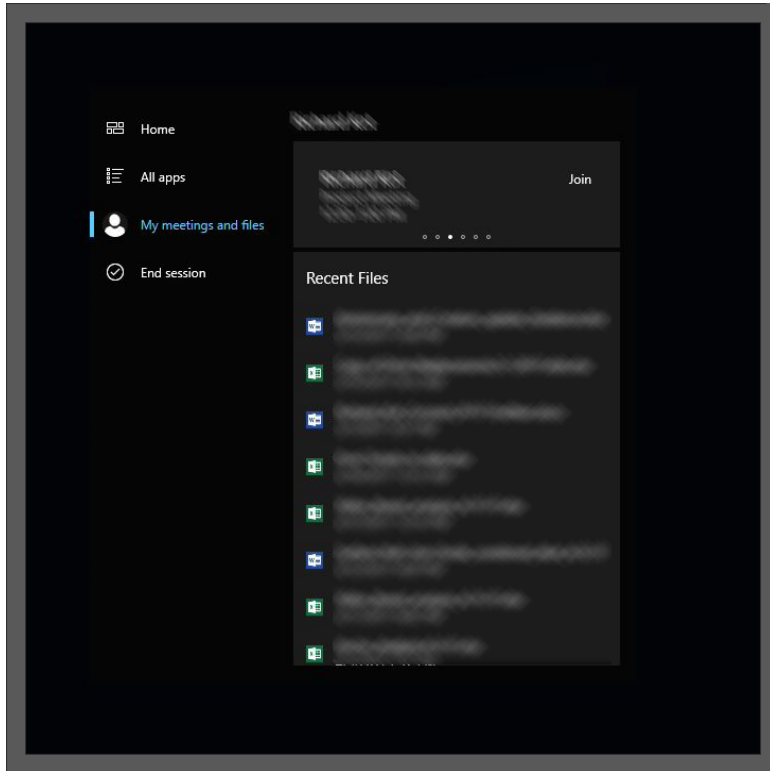

User name and password method

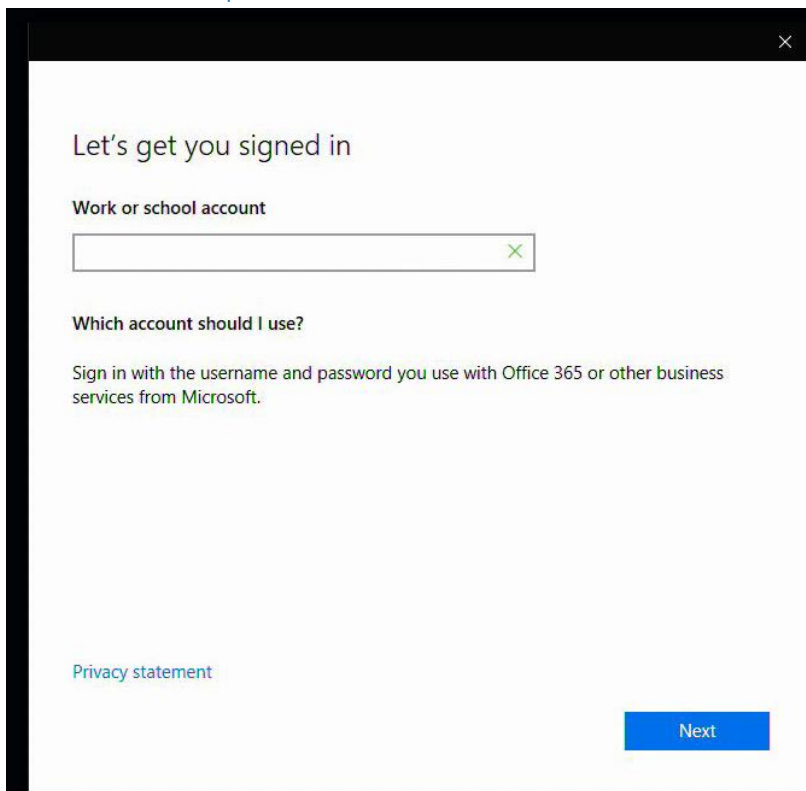

Let's get you signed in

Work or school account

Which account should I use?

Sign in with the username and password you use with Office 365 or other business services from Microsoft.

[Privacy statement](#)

[Next](#)

Enter password

Enter the password for

[Forgot my password](#)

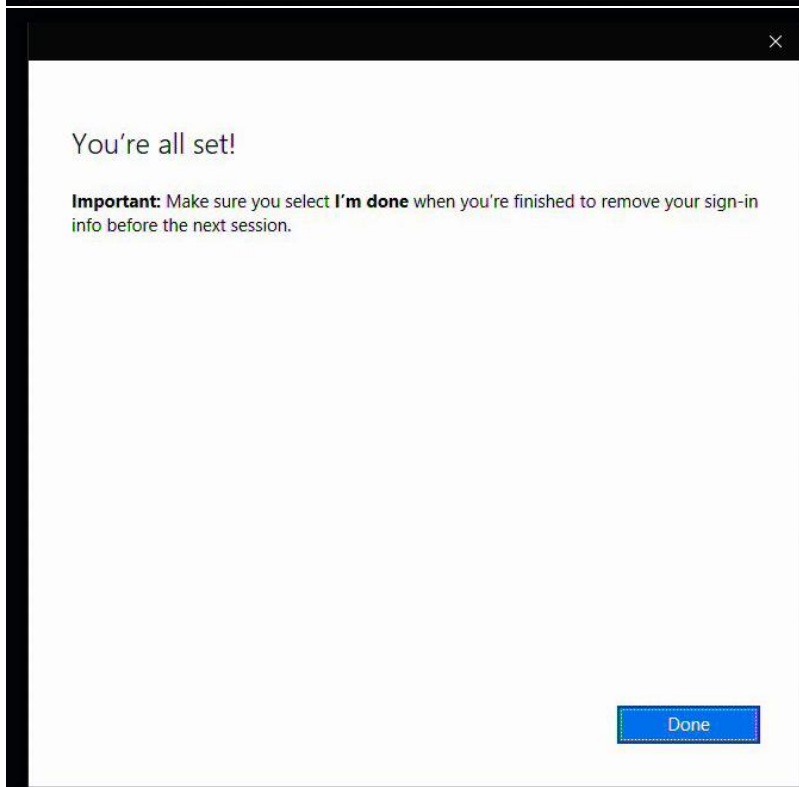
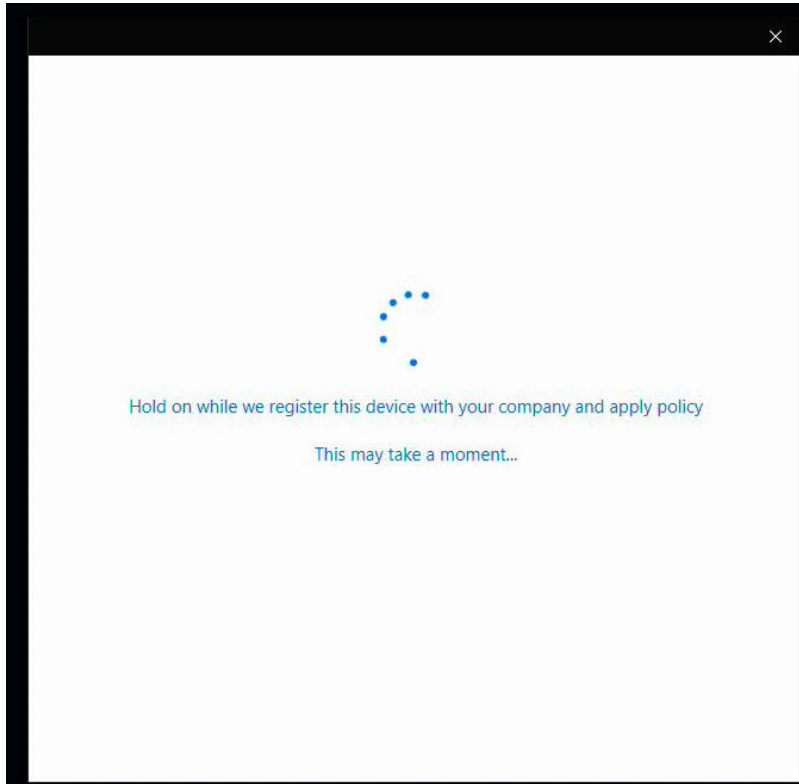

[Privacy statement](#)

[Sign in](#) [Back](#)



Accessibility

The following keyboard commands support ease of access:

Keyboard shortcuts	Action	Use when you want to:
Start key  + ENTER	Turns Narrator on or off	Have Narrator read aloud the text highlighted on the screen
Start key  + =	Increases magnification Opens the magnifier	Enlarge everything on the screen or everything in the magnifier lens (You can also select the + on the magnifier toolbar.)
Start key  + -	Reduces magnification	Shrink everything on the screen. (You can also select the - on the magnifier toolbar.)
Right shift for eight seconds	Turns Filter Keys on or off.	Ignore or slow down brief or repeated keystrokes and adjust keyboard repeat rates.
Shift five times	Turns Sticky Keys on or off.	Press one key at a time for keyboard shortcuts.

After the meeting, these settings will reset to their defaults.

Using the magnifier

To open the magnifier, hold down the Start key  while you press the + key, then select **Magnifier**  to open the magnifier toolbar:



Use the toolbar to select how the magnifier looks (full screen, lens, or docked), adjust other magnification settings, or close the magnifier.

Protect your data

Be sure to email your data at the end of each meeting. When you end a meeting, all your notes and any files you worked on are deleted from the Surface Hub hard drive. If you ever want to wipe the drive, your Surface Hub admin can reset the onboard computer to factory settings.

Your admin can also remove the hard drive if you're concerned about it leaving the premises during repair or replacement. The hard drive is keyed to your Surface Hub and can't be put in a different computer to access data.

For more info on data protection policies, see [FAQ: Protecting your data if you send your Surface in for service](#) on Surface.com.

Care and cleaning

Most glass cleaners are safe for the touchscreen, or you can use rubbing alcohol. Spray the liquid cleaner onto a clean, damp cloth and wipe the screen.

CAUTION Avoid using so much cleaner that it drips off the cloth onto the edges of the screen or into air vents, speakers, microphones, or cable ports.

Keyboard and pen care

To clean the keyboard, wipe it with a lint-free cloth. The keyboard uses two non-rechargeable AAA batteries.

The pens recharge when they're docked on the side of your Surface Hub.

Replacements

For new parts, keyboards, and pens, go to [Surface Hub support](#).

More information

- **Tips app:** Choose this app from the Start screen on your Surface Hub to get up to speed quickly.
- **Additional documents:** Find this file, warranty information, and more at <http://www.microsoft.com/surface/support/surface-hub>.

User Guide for Surface Hub with Windows 10, version 1607







About this guide





Use the Surface Hub User Guide to master the features of Surface Hub, whether in an ad-hoc or scheduled meeting. This guide is also available online at <http://www.microsoft.com/surface/support/surface-hub> along with more Surface Hub information.

To start, familiarize yourself with these icons:

Replacement PC connections icons





Connector, location	Icon	Description
Switch, bottom I/O		Switches between using internal PC or external PC
DisplayPort, bottom I/O		Provides input for replacement PC (normally covered)
DisplayPort, bottom I/O		Provides second input for replacement PC (normally covered)
USB type B, bottom I/O		Provides USB connection for replacement PC to internal peripherals (normally covered)
USB type B, bottom I/O		Provides USB connection for integrated hub (normally covered)

Wired Connect connections icons





Connector, location	Icon	Description
DisplayPort, bottom I/O		Provides input for Wired Connect PC
HDMI, bottom I/O		Provides HDMI input for Wired Connect PC
VGA, bottom I/O		Provides VGA input for Wired Connect PC
3.5mm, bottom I/O		Provides analog audio input
USB type B, bottom I/O		Provides USB connection for video ingest touchback

Additional connections icons

Connector, location	Icon	Description
USB type A, side I/O	None	Provides one USB 3.0 connection for USB devices. Wake-on USB capable.

USB type A, bottom I/O with blue insulator		Provides USB 3.0 connection
3.5mm, bottom I/O		Provides analog audio out
DisplayPort, bottom I/O		Provides mirrored video out function to another display
IEC/EN60320-C13 receptacle with hard switch, bottom I/O	None	Provides AC input and compliance with EU power requirements
RJ45, bottom I/O		Connects to Ethernet
RJ11, bottom I/O		Connects to room control systems

Warning icons

Connector, location	Icon	Description
Attention: Caution		Identifies important safety and health messages
Warning: Hazardous voltage		Dangerous: Do not touch.
Read instructions		Read instruction manual for safety and health information.
Do not open		No user-serviceable parts inside.

Meet Surface Hub

Surface Hub is designed to support meetings, whether participants are around the world or in one room. Both ad-hoc meetings and scheduled Outlook meetings are supported, with Skype for Business as the driving force.

Surface Hub software features include:

- **Skype for Business:** Include Surface Hub in your Skype for Business meeting request. You can present the Surface Hub screen to remote participants, who can view it in their own Skype for Business window. If a remote user has something to present, it appears on the Surface Hub screen. See [Conduct a meeting](#), below.
- **OneNote Whiteboard:** Draw and write on a whiteboard similar to a OneNote page. Copy text and drawings from documents or webpages to the whiteboard, then annotate them. When you're done, mail the page to yourself and anyone else who needs it. See [Whiteboard](#), below.
- **Apps:** Built-in apps include web versions of Microsoft Edge, Word, Excel, PowerPoint, and OneNote. See [Open an app](#), below.
- **Connect:** Project audio and video to your Surface Hub from your computer, tablet, or phone using either cables provided by your Surface Hub administrator or Miracast. See [Connect](#), below.

Surface Hub features

Surface Hub comes in two sizes: 55" and 84", with the following features.



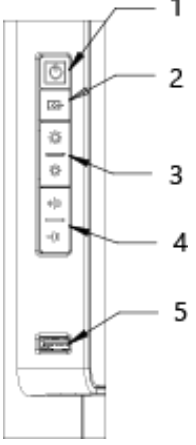

Touchscreen (9)	Use the touchscreen to open apps, write or draw on the whiteboard, join a meeting, invite participants, and more. See Interacting with Surface Hub , below.
Speakers (6) and microphone (1)	Stereo speakers and a microphone let you converse naturally with remote participants.
Cameras (2)	Surface Hub automatically switches between the two cameras so remote users can see the person speaking.
Motion sensors (3) and light sensor (4)	When Surface Hub detects that someone has entered the room, it wakes up and displays the Welcome screen. If it stops detecting movement, it goes to sleep.
Pen charging docks (5)	The Surface Hub pens click into place on the charging docks. Remove a pen to open the whiteboard. Put the pen back in the dock when you're done.
Pens	Use the tip of the pen to write, draw, capture, or select. Use the flat end as an eraser.

Keyboard	Sit back and use the keyboard to operate your Surface Hub. Specialized keys give you quick access to Surface Hub features. See Surface Hub keyboard , below.
NFC reader	This lets you send files from a near-field communications device, such as a smartphone, to the Surface Hub screen.
Integrated computer (10)	Surface Hub has an onboard computer that supports Microsoft Edge and Office 365 apps like Word and PowerPoint.
Keypad (7) and USB 3.0 port (8)	
	Keypad The keypad is on the right side of your Surface Hub, above the pen dock. Use it to set screen brightness (3) and volume (4). See Keypad under Interacting with Surface Hub , below. The keypad also has the power button (1) and source selector (2).
	USB 3.0 port Use the USB 3.0 port—(5) on the keypad—to load files onto your Surface Hub for your meeting.

Wake / sleep

When someone enters the room, Surface Hub wakes up and displays the Welcome screen. When it stops detecting movement, it goes to sleep.

NOTE If your Surface Hub seems to be asleep when you're in the room or does not respond as expected, try the following:

- On the keypad on the side of your Surface Hub, press the Source button  to toggle through the possible video input sources.
- Swipe up from the bottom of the screen. If a menu appears, select Exit Full Screen .

For more info, see [Welcome screen](#), below.

Interacting with Surface Hub

You can interact with your Surface Hub in several ways:

- [Touchscreen](#)

- [Keypad](#)
- [Keyboard](#)

You can use your Surface Hub as a display for your laptop, tablet, or smartphone. See [Connect](#), below.

Touchscreen

Surface Hub is designed for touch. Start a meeting, invite more people to join you, open apps, write on the whiteboard, send the results of the meeting to yourself and others—you can do it all with touch. When you need to enter text, a touch keyboard appears.







Several people can use the touchscreen at once.

- In pen mode, three pens can write on the whiteboard at once. For more info, see [Whiteboard](#), below.
- Touch mode supports up to 100 touch points at once. Use touch to write on the whiteboard and select items in any app.

To switch between pen and touch mode, select the **Touch/Pen toggle**  at the bottom of the screen.

Keypad

The keypad is on the right side of your Surface Hub. It has these buttons:

Icon	Description
	Power: Turns Surface Hub on or off. You'll rarely need to do this. Surface Hub automatically goes to sleep when it detects no activity in the room and wakes up when someone enters.
	Source selector: Cycles through all video input sources—onboard computer, DisplayPort, HDMI port, and VGA port
	Brightness up: Increases screen brightness
	Brightness down: Decreases screen brightness
	Volume up: Increases volume
	Volume down: Decreases volume

Keypad indicator lights

LEDs on the keypad indicate your Surface Hub's power state:

LED	Indicates
Off	No power to your Surface Hub
White	Power is on
Amber	Power is off
Flashing amber	Surface Hub has encountered a problem

Pen indicator lights

LED	Indicates
White	Sleep
Amber	Low battery
Flashing amber	Very low battery
Off	Deep sleep





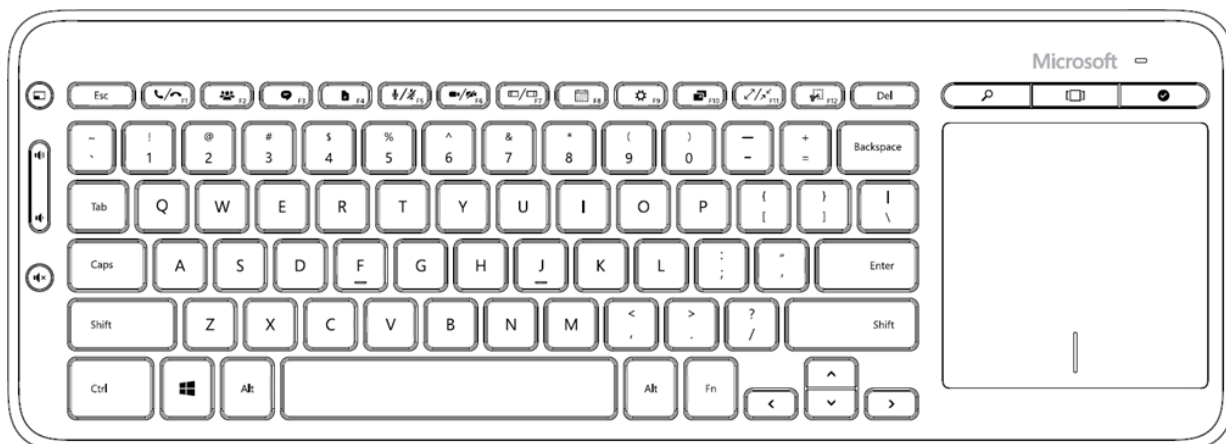



Keyboard

Surface Hub comes with a wireless keyboard that has a touchpad as well as special keys on the top row, down the left side, and above the touchpad.

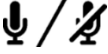
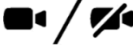
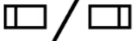



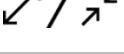

Keys on top row



Icon	Description
	Dial/Hang up: Begin or end a Skype for Business call
	People/Add a person: Opens the people pane

Icon	Description
	Messaging: Opens the messaging sidebar
	Content: Opens the content pane
	Mute/Unmute mic: Toggles to mute and unmute the microphone
	Privacy mode: Toggles to turn the cameras on and off
	Swap sidebar: Moves the sidebar to the opposite side of the screen
	Room calendar: Toggles the room free/busy calendar
	Action center: Opens the action center
	Screen sharing: Toggles to present your screen to other participants or stop presenting it
	Full screen / exit full screen: Toggles the active app in and out of full-screen mode
	Send to whiteboard: Takes a screenshot of the selected app and pastes it to the whiteboard

Keys on left side

Icon	Description
	Left click: Like the left-click button on a mouse
	Volume up: Increases volume
	Volume down: Decreases volume
	Mute: Mutes speakers



Keys above touchpad

Icon	Description
	Search: Launches Search in Microsoft Edge.
	Task view: Lets you choose between open apps or close apps
	End session: Starts the countdown for ending a session—like tapping I'm done on the touchscreen.





Welcome screen







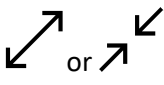

The Welcome screen appears when your Surface Hub wakes up. When you close a session, your Surface Hub resets itself and the Welcome screen reappears.

- If the previous meeting is still active, select **Resume** to reopen it. You'll need to close the previous meeting before you can start a new one.
- To join a scheduled meeting, select it from the list on this screen.
- To start an ad-hoc meeting, select one of these icons:

Icon	Description
	Call: Starts a meeting by inviting remote participants to join, using Skype for Business
	Whiteboard: Launches the Whiteboard app. You can also open the whiteboard by taking a pen from its dock. See Whiteboard , below.
	Connect: Projects your laptop, tablet, or smartphone screen to your Surface Hub. See Connect , below.

Icons you'll see during a meeting



Icon	Location	Description
	Bottom center	Search: Opens Search in Microsoft Edge.
	Bottom center	Start: Displays the All apps list and frequently used apps like Word or PowerPoint.
	Bottom center	Task view: Shows all active tasks on Surface Hub and allows you to switch between them, place two of them side by side, or close them.
	Upper right	Full screen: Expands the current window to fill the screen Exit Full Screen: Swipe up from the bottom of the screen, then select this icon.
	Upper right	Annotate: Places a screenshot of the current page onto the whiteboard. You can then mark up the screenshot.

Icon	Location	Description
	Either side	<p>Call: Adds the first remote participant to an ad-hoc meeting.</p> <p>During a scheduled meeting, or when a meeting already has remote participants, you see additional icons. For more info, see During the meeting, below.</p>
	Bottom right	<p>I'm done: Ends the session. You'll be prompted to save files and session content.</p>
	Bottom right	<p>Notifications: Shows notifications that have come in—like the Action center on your PC running Windows 10—and shows upcoming meetings.</p>
	Bottom right	<p>More: Displays additional icons:</p> <ul style="list-style-type: none"> <li data-bbox="803 814 1063 884">  Do not disturb <li data-bbox="803 913 982 982">  Volume <li data-bbox="803 1012 982 1081">  Restart
	Bottom right	<p>Email: Select at any time during a meeting to send all the meeting notes to that point to any recipient. See Save your data, below.</p>

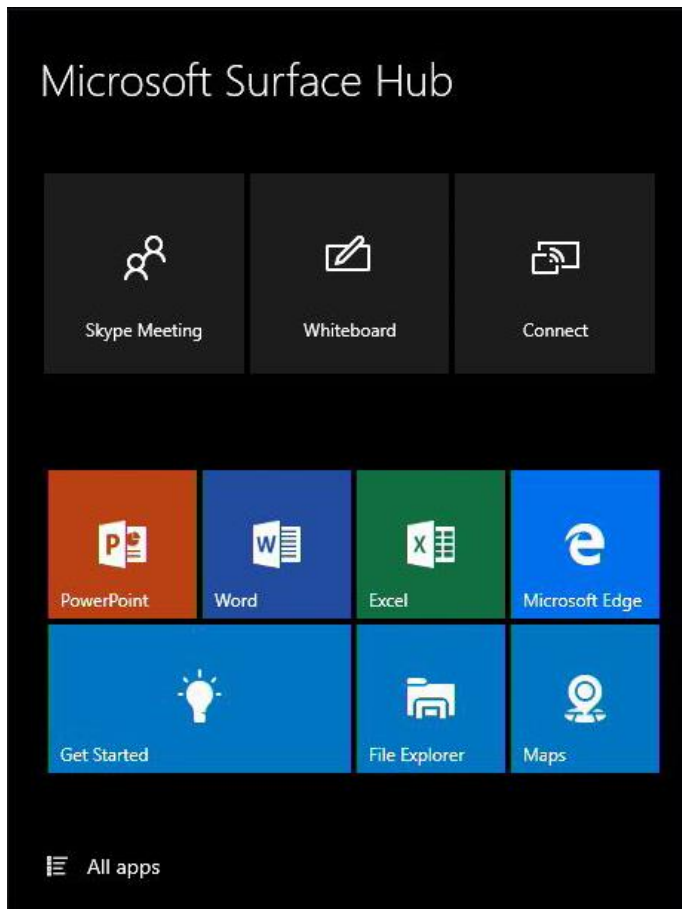
Start screen



At any time, you can go to the Start screen to access the whiteboard, start a call, open apps, and more. Here's how:

- At the bottom of the screen, select **Start** .
- or -
- Press the Start  key on the keyboard.

Open an app

Select a commonly used app like Word or Excel from the tiles on the Welcome screen.

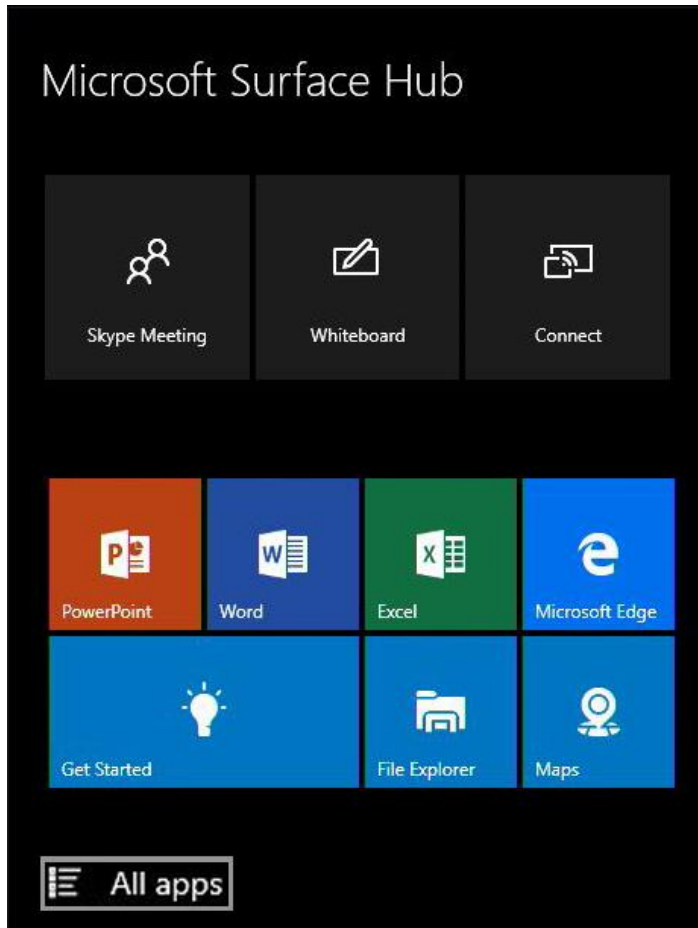

Or, select Start  > **All apps** and select the app you want.

[Switch or close apps](#)

Select **Task view**  at the bottom of the screen and select the app you want.

[Get Started app](#)

The Get Started app is a great way to get up to speed anytime. Consult it anytime you're stuck, or to learn more about Surface Hub features.

To open the Get Started app, select Start  > **Get Started**.



Whiteboard

Whiteboard lets people ink, ideate, and collaborate for brainstorming, diagraming, and annotating on top of content. To begin using Whiteboard, simply remove a pen from its docking station to open Whiteboard or select Start > Whiteboard.







You can also switch to Fingerprint Mode and write with your finger. Whiteboard settings like ink color, selection tool (lasso), and erase apply to everyone working at the whiteboard.

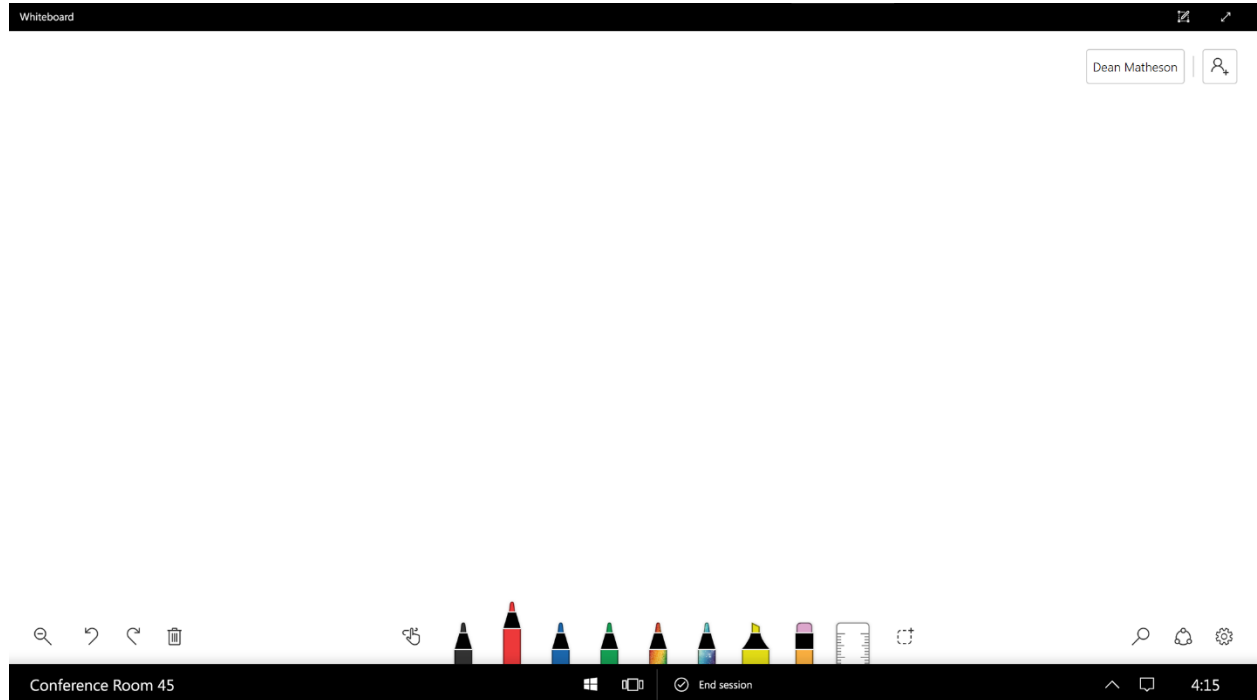



NOTE This guide applies to the version of the existing Whiteboard app that comes installed on Surface Hub and is pinned to the Welcome screen. For help with the new version of the Whiteboard app, released on July, 12, 2018, see the [Microsoft Whiteboard Help article](#). To learn more about rolling out the new version for your Surface Hub, see this [Microsoft Whiteboard Surface Hub opt-in article](#).







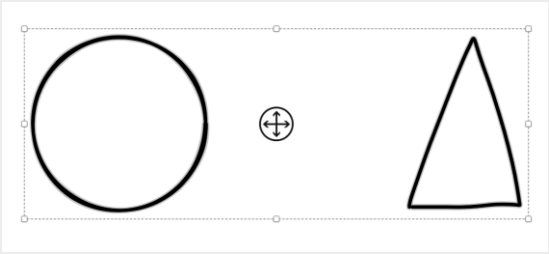

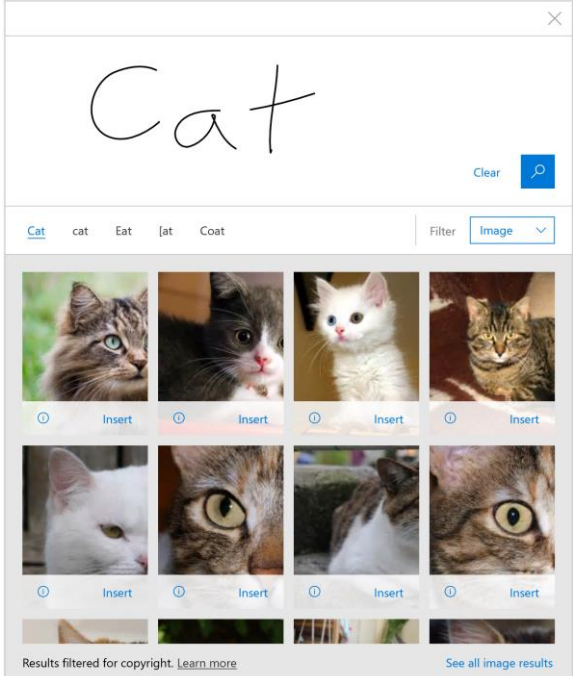

Whiteboard menu

The menu is at the bottom of the whiteboard screen.



Icons	Description
	<p>Bird's Eye View: Tap to see a zoomed-out version of the current whiteboard. You can then select with the pen or your finger any content and place it around the canvas. You can also tap to zoom in to that location.</p>
	<p>Undo: Tap to undo the last action. Note: this action is unavailable during a collaboration session.</p>
	<p>Redo: Tap to redo the last action. Note: this action is unavailable during a collaboration session.</p>
	<p>Trash: Erase everything on the whiteboard. Note: this action is unavailable during a collaboration session.</p>
	<p>Fingerprint Mode: Switch between using pen (fingerprint inactive) and touch (fingerprint active) for inking, erasing, and highlighting.</p>
	<p>Color: Select black, red, blue, green, rainbow, galaxy, and highlighter colors. The color you choose applies to touch or pen marks from all participants. A raised pen indicates which color you're using.</p> <p>Note: Highlighter appears on top of other colors so it doesn't mask them.</p>
	<p>Erase: Erase content using touch or a pen. When Erase is selected, the tip of the pen works as an eraser. At any time, you can still use the flat end of a pen as an eraser.</p>

	<p>Ruler: Tap the Ruler to enable it and then use your fingers to position it on the screen. Once positioned, use a pen (or your finger (if in Fingerprint Mode)) to draw straight lines along the edges of the ruler.</p> <p>Note that you can use three fingers to pivot the Ruler in 5 degree increments.</p>
	<p>Lasso: Circle an area to select all the images within it. Images that are entirely inside the lassoed area are outlined in gray and defined by a box.</p>  <p>Select and drag any corner of the selected area to resize the image.</p> <p>Select Move  and drag it to relocate the lassoed section.</p> <p>Press and hold a lassoed section with a pen or finger to cut or copy a lassoed image or to paste an image from the clipboard</p>
	<p>Search: Tap to write in a search term and see images related to that term. Whiteboard uses Bing Image Search with Safe Search set to Strict.</p> <p>The first set of results are images with a Creative Commons license for reuse. You can see additional results by tapping See all image results:</p>

	 <p>Using Bing Image Search in Whiteboard requires that you agree to privacy terms.</p>
	<p>Share: Tap to reveal the share charm so you can email an image and a .one file of the whiteboard or save it to your OneDrive.</p>
<ul style="list-style-type: none">  Ink to Shape <input checked="" type="checkbox"/> On  Ink to Table <input checked="" type="checkbox"/> On  Show Angles on Shapes <input checked="" type="checkbox"/> On  Send Feedback >  Privacy Options >  About >  Help > <div style="text-align: right; margin-top: 10px;"></div>	<p>Ink to Shape automatically converts simple shapes like triangles, circles, rectangles, and more to clean, tidy ones.</p> <p>Ink to Table automatically converts a rectangle bisected with horizontal or vertical lines into a table with columns and rows that you can fill with ink or other information.</p> <p>Show Angles on Shapes requires that Ink to Shape be enabled and allows you to tap on shapes to see the angles for each vertex. You can adjust the angles by dragging the corner of the shape.</p> <p>Gear: Tap to set default smart ink options like Ink to Shape, Ink to Table, and Show Angles on Shapes.</p> <p>You can also send feedback via the Feedback Hub, turn on or off privacy options for Bing Image Search or view more information about the application.</p>
<div style="border: 1px solid #ccc; padding: 5px; display: inline-block;">Sign in</div>	<p>Sign in: Tapping Sign in allows you to initiate a collaboration session with other Surface Hubs if your organization is using Office 365, has OneDrive for Business</p>

	<p>deployed, and is not using <i>Office 365 Germany</i> or <i>Office 365 operated by 21Vianet</i>.</p>
	<p>Collaborate: Tapping the button next to your name allows you to generate a collaboration link and share it with others on Surface Hubs so they can collaborate on the same whiteboard as you.</p> <p>Please note that this button only appears if your account can leverage the Whiteboard collaboration feature. If you believe you should be able to collaborate but don't see the button, please contact your IT administrator.</p>

Smart Ink

Whiteboard includes smart ink features that help you write, draw, and work together more efficiently.

Feature	Description
<p>Ink to Shape</p>	<p>With Ink to Shape enabled, all simple shapes including triangles, circles, rectangles, and other polygons drawn by hand will automatically be cleaned up into straight-lined shapes.</p>
<p>Ink to Table</p>	<p>With Ink to Table enabled, you can create tables on the canvas that have rows and columns so you can more easily collect and work with data in whiteboard.</p> <p>To create a table, first draw a rectangle or square (with or without Ink to Shape enabled). Then draw a straight vertical or horizontal line that fully bisects the rectangle or square. Horizontal lines create new rows and vertical lines create new columns.</p> <div data-bbox="500 1192 1307 1522" data-label="Image"> </div> <p>Once you've created a table, you can also add and remove columns or rows by tapping on a row or column and pressing the + or – buttons to remove/add. You can also highlight cells by inking with the highlighter anywhere within a cell. Highlighting the cell again removes the highlight.</p>
<p>Shown Angles on Shapes</p>	<p>To use Show Angles on Shapes, you must have Ink to Shape enabled and have a shape with angles recognized (circles won't work). Once you have a recognized shape and made sure you have Show Angles on Shapes enabled, tap on the shape to see the angles for that shape. You can grab the vertices of the shape to change the angles:</p>

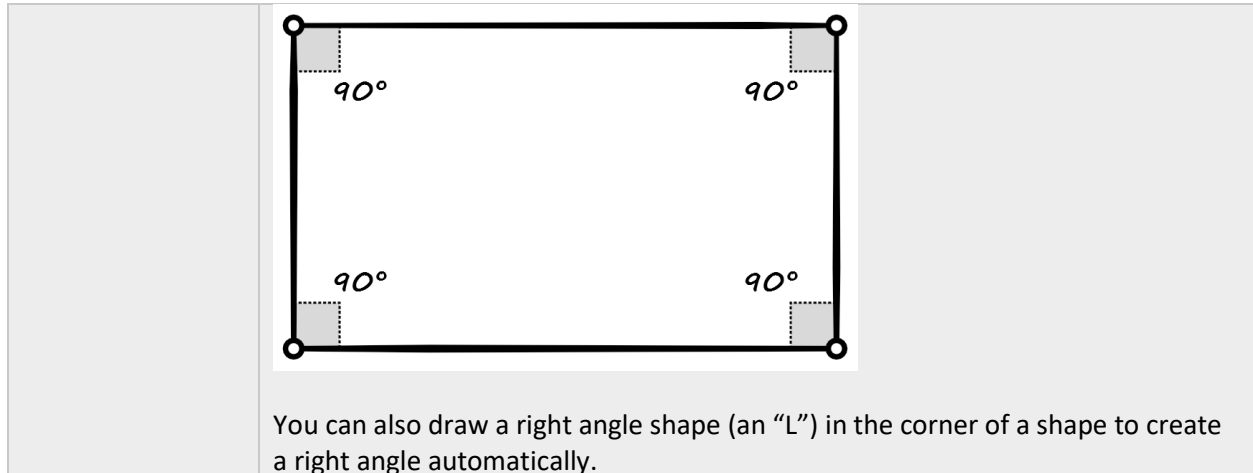

Whiteboard to Whiteboard collaboration

Whiteboard now allows you to remotely collaborate with other users on the same whiteboard so you can ink, work, and collaborate in real time.

To use Whiteboard to Whiteboard collaboration, you need to make sure that your organization and Surface Hub meet the following requirements:

- Office 365 with cloud-based Azure Active Directory (Azure AD) for all users
- OneDrive for Business deployed for all users who intend to collaborate
- Currently not utilizing Office 365 Germany or Office 365 operated by 21Vianet
- Surface Hub needs to be updated to Windows 10, version 1607 or newer

If you have questions, reach out to your IT administrator for more information.

To start a collaboration session:

6. In the Whiteboard app, tap the **Sign in** button.
7. Sign in with your organization ID.
8. Tap the **Invite** button next to your name at the top of the app.
9. Tap **Start session**. Whiteboard will generate a link that you can share.

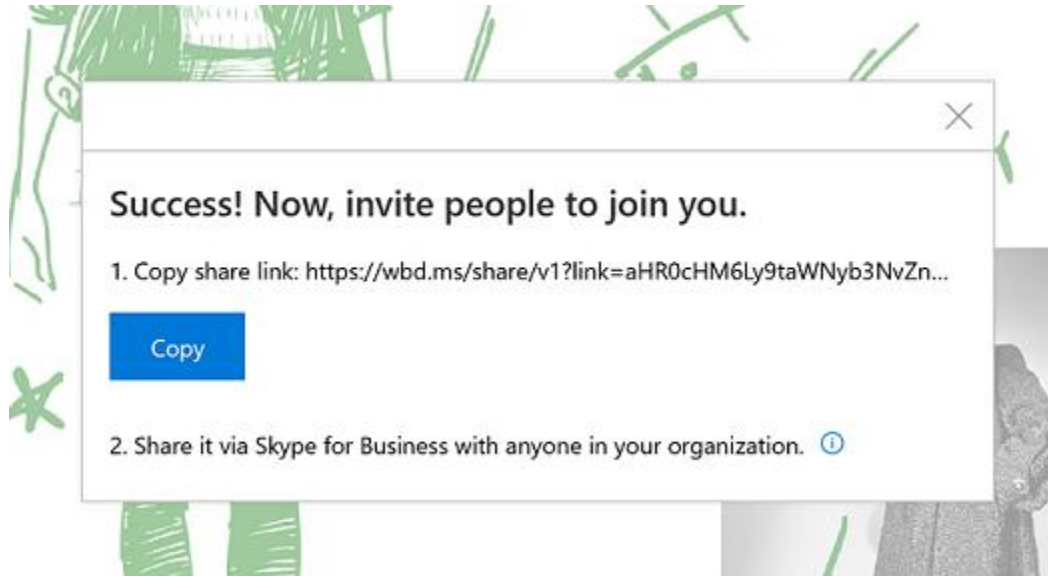

10. Copy and paste this link into a Skype chat with another Surface Hub

When the other Surface Hub receives the link, the recipient can tap on the link, sign in to Whiteboard, and then begin collaborating. You can copy and paste other content, use smart ink features like Ink to Shape, and co-author together.

After you're done, you can export a copy of the Whiteboard collaboration for yourself through the Share charm and leave the board for others to continue working.

Connect



Use the Connect feature to project the screen and audio from your laptop, tablet, or phone to your Surface Hub. Connect supports these special features:

- **Touchback:** Lets you control your connected laptop, tablet, or phone from the Surface Hub touchscreen.
- **Inkback:** When you project an app that supports inking to Surface Hub, any markups done on the Surface Hub screen appear in the file on the device you're using to project. For example, if someone circles a paragraph in a Word doc on the Surface Hub screen, that circle appears in the file on the tablet you used to project the file. If you save the file on the tablet, you also save the circle around the paragraph.

Connections can be wireless or wired.

Wireless Connect

If your phone, laptop, or tablet supports Miracast, you can project your screen wirelessly to your Surface Hub. Here's how, if you're using Windows 8 or later:

4. Press the Start key +K or open the **Action center**  and select **Connect**.
5. Select the name of your Surface Hub from the list that appears.

6. If prompted, enter the PIN that appears on the touchscreen.

For other types of devices, check the manufacturer's website for instructions.

Wired Connect

If your system admin has set up a wired connection to the Surface Hub, you can connect by plugging a cable into your laptop or tablet.

- Plug in the video cable that works with your device (DisplayPort, HDMI, or VGA).
- If you want to use Touchback and Inkback, plug in the USB 2.0 cable.
- If you're using a VGA cable and you want to include audio, plug in the 3.5mm audio cable.

Conduct a meeting

All activities and sessions on your Surface Hub are considered meetings, either ad-hoc or scheduled. Aside from scheduling, there's no difference between them. All of your Surface Hub's features and applications are available in both.

You can use Skype for Business to invite remote participants during any meeting. See [Add participants during a meeting](#), below.

NOTE To join a meeting with Surface Hub, remote participants may need to download software and set up an account to use Skype for Business. For details, see [Skype Downloads](#) on [skype.com](#).

Your meeting session stays open until you close it, even if another meeting is scheduled after yours and you run late. At the end of a meeting, you must close the session. Be sure to email any meeting notes you want to keep before you close the session. To protect your privacy, Surface Hub deletes all the notes from your meeting when you close the session.

Start an ad-hoc meeting

You can start an ad-hoc meeting in several ways:

- Touch one of the icons on the Welcome screen.
- Press the **Start** key  on the Surface Hub keyboard.
- Connect your device to the Surface Hub using cables or Miracast.

You can then invite others to join your meeting through Skype for Business.

Start a scheduled meeting

Set up a scheduled Skype meeting in Outlook, with your Surface Hub as a participant. Remote participants can join the Skype for Business meeting using Skype for Business on another Surface Hub or their own device. PowerPoint files can be uploaded into your Skype for Business meeting and viewed by local participants on the Surface Hub, as well as by remote participants. Upcoming scheduled meetings are listed on your Surface Hub in Notifications and on the Welcome screen. To join a scheduled meeting, select it from the Surface Hub screen.

Invite people to your meeting

Schedule a meeting



Use Outlook to schedule a Skype for Business meeting that includes your Surface Hub and any remote Surface Hubs that other participants will be using.

Add participants during a meeting

To add the first person to an ad-hoc meeting:

1. Select **Call**  on either side of the screen.
2. Do one of the following:
 - Select **Search for someone**, enter the name or email address of the person you want to invite, and select the name from the list. Then select **Invite**.
The person you invite will get a pop-up invitation in Skype for Business.
 - Select **Make a phone call** and enter the number of the person you want to call.

To invite additional people to a scheduled or ad-hoc meeting:



3. Select **People**  on either side of the screen, then select **People plus** .
4. Enter the email address of each person you want to invite and select the name from the list. Then select **Invite**.
The person you invite will get a pop-up invitation in Skype for Business.

For more info, see [Skype for Business](#).

Before the meeting

You can join the meeting before it starts to get things ready. Just select the link for your meeting from the Surface Hub Welcome screen.



If the previous meeting was left running, you'll need to close it before you start your meeting. This will delete all data from that meeting. To be courteous, email the organizer's notes and data before closing.

If it was a scheduled meeting, select Email . The organizer's email address is filled in automatically. If the previous meeting was ad-hoc but you know who was using the Surface Hub, select Email  and enter the person's email address.

During the meeting

During the meeting, you can take notes and draw on the whiteboard. At the end of the meeting, send these notes to anyone who needs them as a OneNote page or a .png image file.

During a Skype for Business meeting, additional icons appear on the sides of the screen:

	<p>People: Shows the people participating in the Skype for Business call.</p>
	<p>Messaging: Displays IM conversations among participants.</p>
	<p>Content: Shows the list of documents that have been uploaded to the meeting space.</p>

Accessing content attached to meeting invite

Prior to an attachment being visible on the Surface Hub, the Skype for Business meeting originator must present the content while connected to the meeting. Begin by choosing Present->Manage Content on the meeting originator's Skype for Business client.

Note: Pre-loading meeting attachments is a feature in Skype for Business Online only.

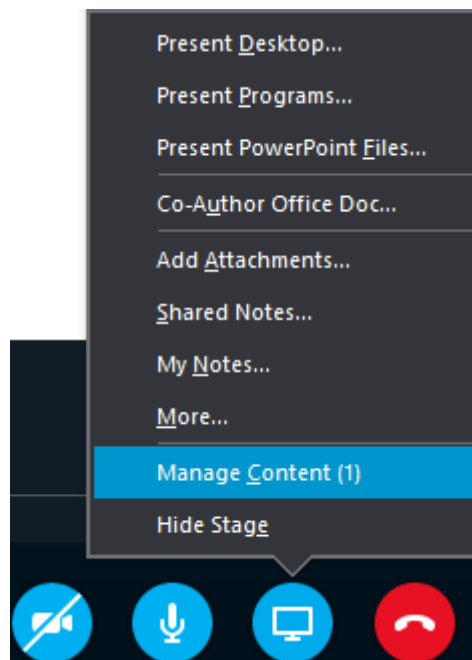

PowerPoint content that was attached to the Skype meeting invitation will be displayed. Choose the PowerPoint you would like to share and click the “Start Presenting this content” icon

 on the far left.

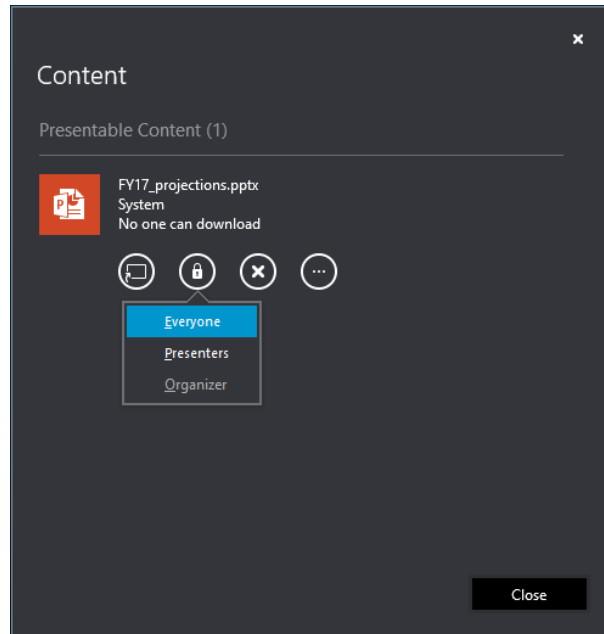

To begin displaying this content on the Surface Hub, a user must first request a pin number. This is done to protect your content from unauthorized viewing. On the Surface Hub, click **Content**  from the menu at the left or right edge of the Surface Hub screen and then choose the PowerPoint file you wish to view.

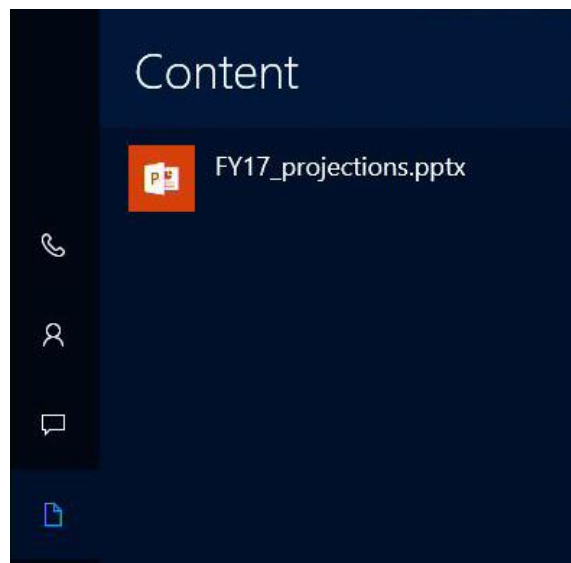

Click the "Get a Content PIN" button to request a new PIN from the content owner.

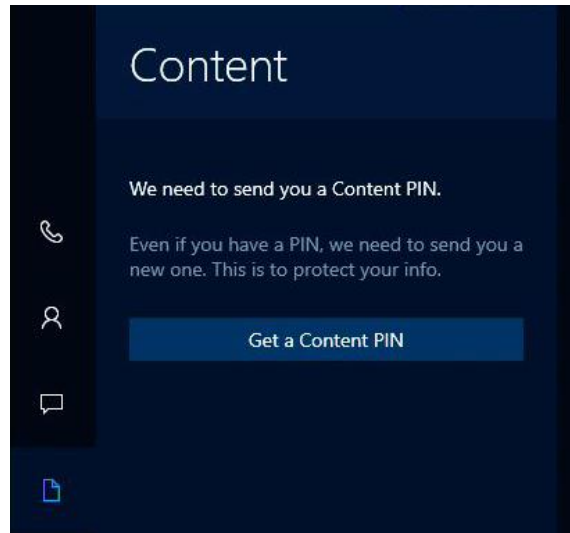

Choose the content owner member that is present and hit send. This individual should be present in the same room as the Surface Hub for quick Pin retrieval.

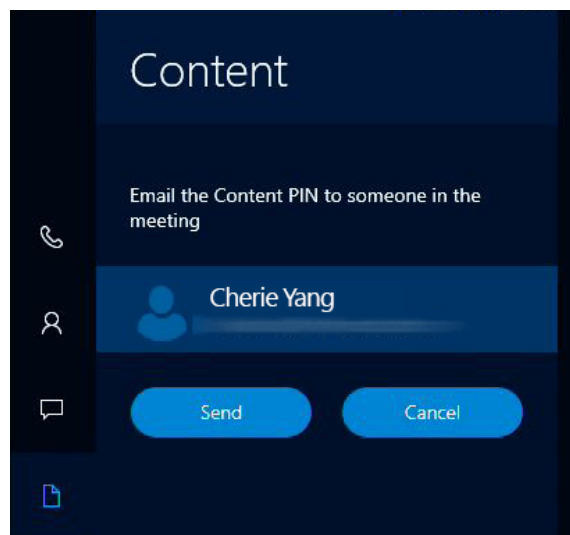

An email containing the four-digit code will be sent to this user. Once received, enter the Content PIN into the next window.

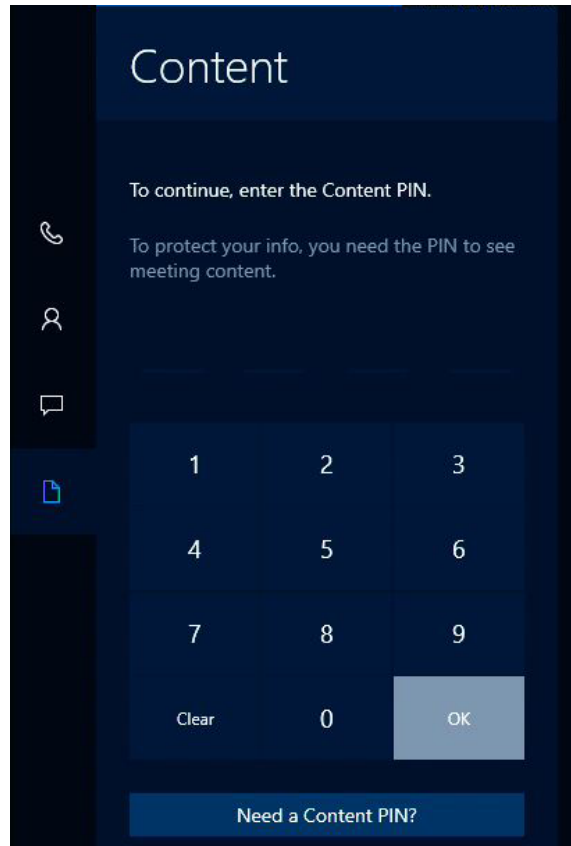

The PowerPoint file will now be presented on the display as well to the remote participants.

[Share content with remote participants](#)

Sharing your Surface Hub screen is a lot like sharing your screen in Skype for Business.

- Select **Present** to start sharing.
- Select **Stop presenting** when you're done.

[Upload content to the meeting space.](#)

During a Skype for Business session, remote users can share PowerPoint files with the Surface Hub as well as all participants. Any shared files will be shown on the Surface Hub in the Content tab .

To begin sharing a file with the meeting participants click **Present**  within your Skype for Business desktop client and choose **Present PowerPoint Files**.

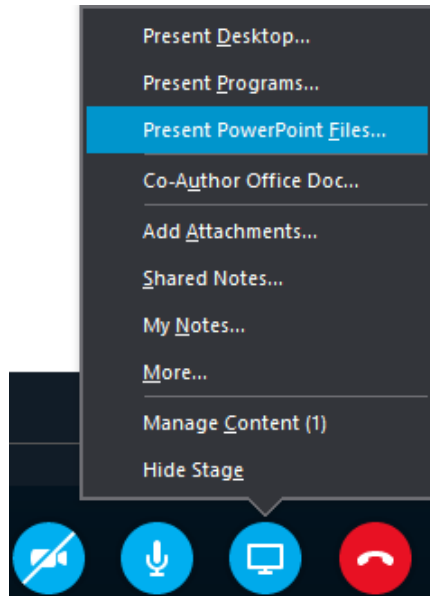

Once you have chosen your file and clicked **Open**, the file will be automatically shared and uploaded to the meeting space. Click the Content tab icon  to select the file you want to present.

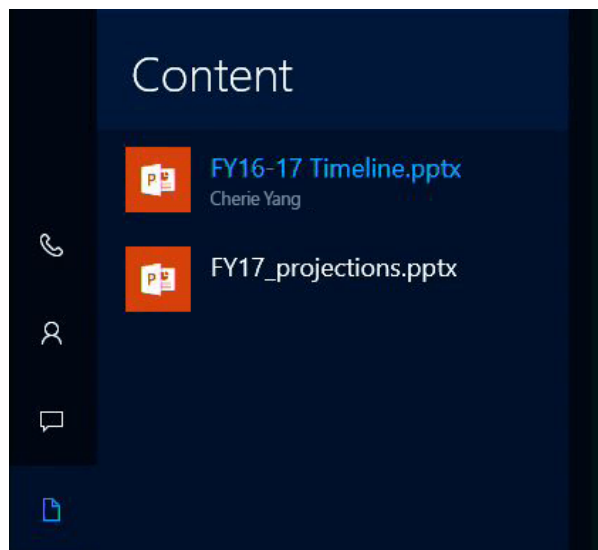

Adjust cameras, mic, and volume



During a Skype for Business session, select **Messaging** . Then choose any of the following settings:

- Active camera
 - **Automate camera settings:** Let your Surface Hub determine which camera to use. The camera will use sound and motion detection to focus on who's talking. A light appears under each camera.
 - **Left camera:** Use the left camera only. A light appears under the left camera.

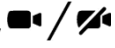
- **Right camera:** Use the right camera only.
A light appears under the right camera.
- **Camera off:** Turn off both cameras.
No light appears under either camera.

You can also turn off the cameras from the Surface Hub keyboard by pressing the **Privacy**  key.

- Microphone muting

If the mic is active, the **Microphone**  icon appears. If it's muted, the **Muted microphone**  icon appears. Do either of the following to toggle between these settings:

- On the touchscreen, select the icon to toggle between muted and active.
 - On the keyboard, press the **Microphone** key .
- Volume control setting
 - On the keypad, press one of the volume buttons.
 - On the touchscreen, slide the volume to the level you want.
 - On the keyboard, press the volume up or volume down button.

Use apps in split-screen mode

When you open a second app, it appears alongside the first app. You can open more than two apps, but only two can be displayed at once. Here's how to open more than one app.

5. Open the first app, for example the Whiteboard app or a Word doc.
6. Select Start  > **All apps** and select the second app. Repeat to open additional apps.

To hide one of the apps, drag the vertical black bar toward the app you want to hide until the app disappears.

To display the app again or change which apps are displayed:

7. Select **Task View**  at the bottom of the screen.
8. Drag the app you want to the side of the screen where you want it to appear.

Annotate

To copy an image of a page in an open document to the whiteboard and mark it up, select the document and select **Annotate** .

Save your data

Be sure to save your changes before ending the meeting. How you do that will depend on which apps you used.

- Changes made to apps running on your Surface Hub, such as Whiteboard, Word, Excel, and PowerPoint, must be emailed to a person or team.
- Changes made to data on your computer and projected to your Surface Hub can be saved to your computer.

IMPORTANT Your data can be irretrievably lost after you end your meeting. Be sure you email everything, or upload it to OneNote. Here's how:

9. Select **Email**  at the bottom right of the screen.
10. Select **To:** and enter the email addresses, or select **OneDrive** and follow the steps.
11. Select **Send**.

End the meeting

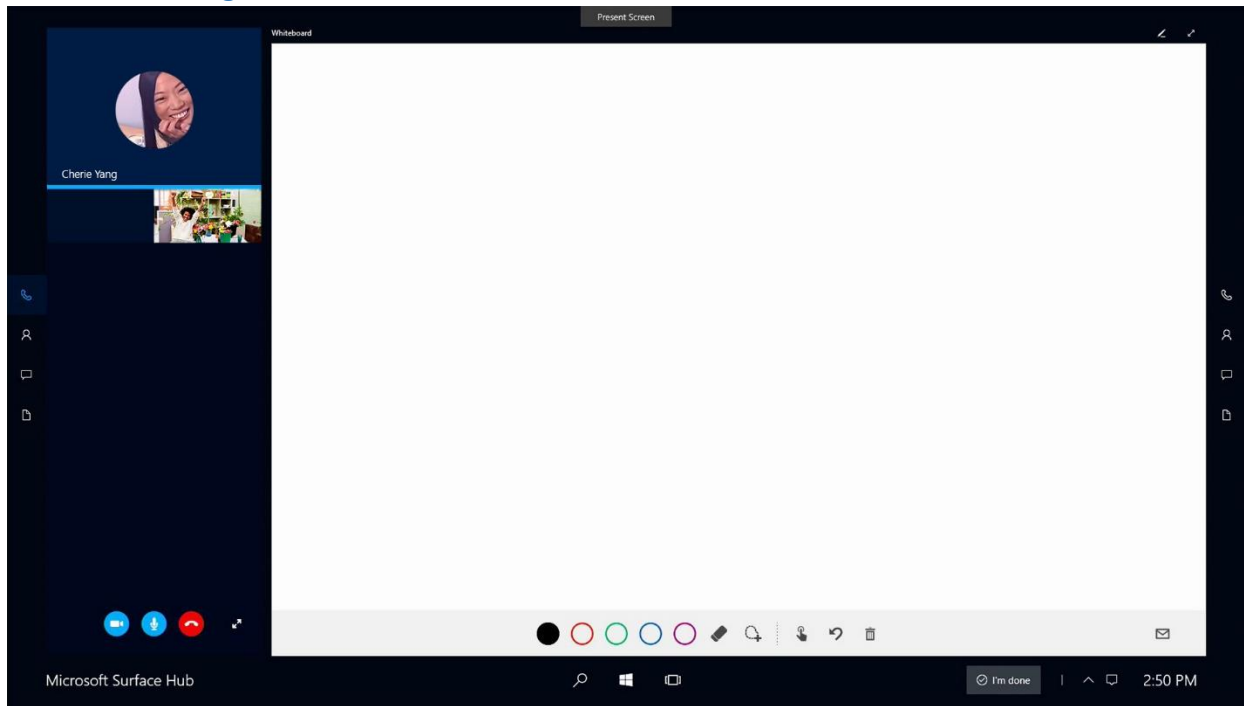

To end a meeting, select **I'm done** at the lower-right corner of the touchscreen or press the End session key  on the keyboard.

When you select **I'm done**, you'll see a brief countdown during which you can go back and save your data. This is your last chance to save any files.

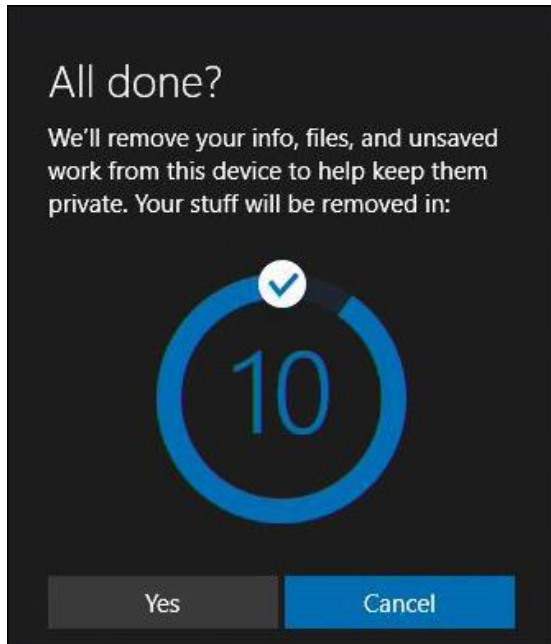

When you end your meeting:

- If you're projecting to your Surface Hub from a device in the room, that connection closes.
- If you're in a Skype for Business meeting, your Surface Hub leaves the meeting.
- Any open applications on your Surface Hub close.
- Data and files from the meeting are deleted.

NOTE Selecting **I'm done** closes only the local session. People using another Surface Hub can continue the meeting with all the apps still open.

What if I forget to end my meeting?

If you forget to end your meeting, the session goes to sleep but does not time out. The next time someone enters the room, the Welcome screen appears with a prompt to resume the meeting. This means that all the files and information from your meeting will be available to the next group.

The next group using the Surface Hub can email your data to you if it was a scheduled meeting or if they know you were the last one to use the Surface Hub. Or, they can just end your meeting, discarding all your session data.

Restart a meeting



If you're having problems with your Surface Hub, you can restart the meeting.

12. Email the data to yourself.
13. End the meeting.
14. Start a new meeting and load the data you saved.

If restarting doesn't solve the problem, contact your system admin.

Accessibility

The following keyboard commands support ease of access:

Keyboard shortcuts	Action	Use when you want to:
Start key  + ENTER	Turns Narrator on or off	Have Narrator read aloud the text highlighted on the screen
Start key  + =	Increases magnification Opens the magnifier	Enlarge everything on the screen or everything in the magnifier lens (You can also select the + on the magnifier toolbar.)
Start key  + -	Reduces magnification	Shrink everything on the screen. (You can also select the - on the magnifier toolbar.)
Right shift for eight seconds	Turns Filter Keys on or off.	Ignore or slow down brief or repeated keystrokes and adjust keyboard repeat rates.
Shift five times	Turns Sticky Keys on or off.	Press one key at a time for keyboard shortcuts.

After the meeting, these settings will reset to their defaults.

Using the magnifier

To open the magnifier, hold down the Start key  while you press the + key, then select **Magnifier**  to open the magnifier toolbar:



Use the toolbar to select how the magnifier looks (full screen, lens, or docked), adjust other magnification settings, or close the magnifier.

Protect your data

Be sure to email your data at the end of each meeting. When you end a meeting, all your notes and any files you worked on are deleted from the Surface Hub hard drive. If you ever want to wipe the drive, your Surface Hub admin can reset the onboard computer to factory settings.

Your admin can also remove the hard drive if you're concerned about it leaving the premises during repair or replacement. The hard drive is keyed to your Surface Hub and can't be put in a different computer to access data.

For more info on data protection policies, see [FAQ: Protecting your data if you send your Surface in for service](#) on Surface.com.

Care and cleaning

Most glass cleaners are safe for the touchscreen, or you can use rubbing alcohol. Spray the liquid cleaner onto a clean, damp cloth and wipe the screen.

CAUTION Avoid using so much cleaner that it drips off the cloth onto the edges of the screen or into air vents, speakers, microphones, or cable ports.

Keyboard and pen care

To clean the keyboard, wipe it with a lint-free cloth. The keyboard uses two non-rechargeable AAA batteries.

The pens recharge when they're docked on the side of your Surface Hub.

Replacements

For new parts, keyboards, and pens, go to [Surface Hub support](#).

More information

- **Get Started app:** Choose this app from the Start screen on your Surface Hub to get up to speed quickly.
- **Additional documents:** Find this file, warranty information, and more at <http://www.microsoft.com/surface/support/surface-hub>.

Changes

June 2017	Added instructions for updated Whiteboard app, including Whiteboard to Whiteboard collaboration.
August 2017	Corrected the information in the "Start a scheduled meeting" section.
July 2018	Added information and links about the new Whiteboard app.